

ACS II -4000
ACS II -3000
INSTRUCTION MANUAL

Fundamentally, ACS II-3000 is almost same as ACS II-4000 concerning the operations.

However, you cannot use the upper surfaces of the calibration block as the temperature reference, because we cannot guarantee the accuracy.

In case of ACS II-3000, please use only the internal calibration device.

AE-100231

3rd Edition December 2021

ANRITSU METER CO., LTD.

<http://www.anritsu-meter.co.jp>

Introduction

Thank you for purchasing this Anritsu Meter Co., Ltd. product.

This instruction manual was written to ensure safe and correct use of the instrument. Do not attempt to operate the instrument until you have carefully read this manual and gained a good understanding of its various functions.

Technical Fax-back Service:

As an added service to our customers, Anritsu Meter Company offers a FAX-back service to help users of its instruments achieve optimal temperature measurement. Anritsu's specialists in temperature measurement are ready to provide technical assistance in order to help you obtain maximum performance from your measurement.

When requesting technical assistance by FAX-back, be sure to include figures, diagrams and photographs to supplement your explanation of the problem. Please describe the problem in as much detail as possible. Use A4-size paper, write "Technical Service Request" as the top, and then fax your request to the number below. Please do not forget to include contact information such as your name, company name and address, telephone number, and FAX number.

Anritsu's Technical Service FAX-back Number is:

Dialing from Japan: 03-3493-6729

Dialing from overseas: +81-3-3493-6729

Caution:

- Reproduction of any part of this manual, in any form, without written permission from Anritsu Meter Company is prohibited.
- Every effort has been made to provide a clear and complete description of the any aspect of this instrument, contact Anritsu Meter Company or your nearest sales representative.
- Anritsu Meter Company assumes no responsibility for loss or damage due to use of this product.
- The contents of this manual and the specifications of this product are subject to change without notice.

Contents

1. Outline	- 1 -
2. Unpacking and Repacking	- 2 -
2-1 Unpacking	- 2 -
2-2 Repacking	- 2 -
3. Part Names and Locations	- 3 -
3-1 Controller unit	- 3 -
3-2 Calibration block unit.....	- 3 -
4. Preparation	- 4 -
4-1 Cable connections.....	- 4 -
4-2 Connection of standard sensor for calibration	- 4 -
4-3 Power cord connection	- 5 -
4-4 Operation Check	- 6 -
5. Operation	- 7 -
5-1. Turning on/off the power and heater ON and OFF.....	- 7 -
5-2. Temperature Control	- 8 -
5-2-1. setting the surface temperature of the block.....	- 8 -
5-2-2. setting the PID values	- 9 -
5-3 Heating and cooling time.....	- 12 -
5-3-1 Heating time.....	- 12 -
5-3-2 Cooling time.....	- 12 -
5-4 Calibration	- 13 -
5-4-1 Calibration method	- 13 -
5-4-2 Sensor-only calibration	- 14 -
6. Explanation of Instrument Operation	- 15 -
6-1 System structure.....	- 15 -
6-2 Standard sensors	- 15 -
6-2-1 Sensor for temperature control	- 15 -
6-2-2 Standard sensor for calibration.....	- 15 -
6-3 Surface and internal temperature distribution of the calibration block.....	- 16 -
6-4 Controller	- 16 -
6-4-1 PID control	- 16 -

6-4-2 Auto tuning.....	- 17 -
7. Surface temperature definition and confirmation	- 18 -
7-1 Surface temperature definition.....	- 18 -
7-2 Surface temperature confirmation.....	- 18 -
8. Traceability	- 20 -
8-1 Definition of traceability.....	- 20 -
8-2 Traceability	- 20 -
8-2-1 Traceability system.....	- 20 -
8-2-2 Traceability of surface and internal temperature calibrator.....	- 20 -
9. Basic Knowledge of Surface Temperature	- 22 -
9-1 Seebeck effect	- 22 -
9-2 Thermoelectromotive force characteristics.....	- 22 -
9-3 Difference between surface and internal temperatures	- 23 -
10. Pointers for Accurate Calibration	- 26 -
10-1 Calibration environment	- 26 -
10-2 Sensor handling	- 26 -
11. Troubleshooting	- 28 -
12. Maintenance	- 29 -
12-1 Storage and reuse	- 29 -
12-2 Periodic return calibration	- 29 -
12-3 On-site test service	- 29 -
13. Specifications	- 30 -
13-1 General accuracy.....	- 30 -
13-2 Controller unit	- 30 -
13-3 Calibration block unit.....	- 31 -
13-4 Accessories.....	- 31 -
13-5 Options	- 31 -
14. Warranty and After-Service	- 32 -
14-1 Warranty	- 32 -
14-2 After-service	- 33 -

1. Outline

The ACS II -4000 system provides comparative calibration of surface and internal temperature sensors.

Consistent calibration is made possible through the use of copper, with its high heat capacity, in the calibration probe. The probe is designed for application to both surface and internal temperature sensors. Highly accurate calibration is obtained through the use of a platinum resistor as the standard sensor for comparative calibration.

2. Unpacking and Repacking

2-1 Unpacking

Extreme care has been taken when packing this product. Carefully confirm that the parts listed below are present when the case is first opened. Contact the service counter at Anritsu Meter Company or the place of purchase in the event that anything is missing or broken, or if any section of the warranty is blank or has been incorrectly filled out.

Part name	Quantity
Controller unit	1
Calibration block unit	1
Power cord	1
Calibration block heater cable	1
Calibration block sensor cable	1
Standard sensor for calibration (Pt100Ω platinum resistor)	1
Instruction manual	1
Warranty	1

2-2 Repacking

Extreme care should be used when transporting the meter. Take precautions to protect the meter from shock and vibration.

Dust and moisture absorbed in the packaging can damage the instrument. Confirm that the packing materials are dry and free from dust before using.

3. Part Names and Locations

3-1 Controller unit

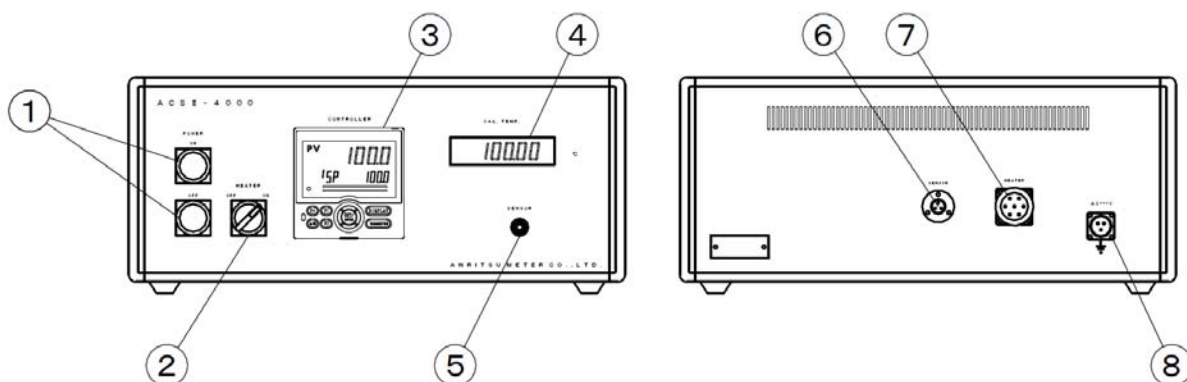

- ① Power switch
- ② Heater switch
- ③ Display
- ④ Display for standard sensor
- ⑤ Connector for standard sensor
- ⑥ Sensor cable connector
- ⑦ Heater cable connector
- ⑧ Power connector

3-2 Calibration block unit

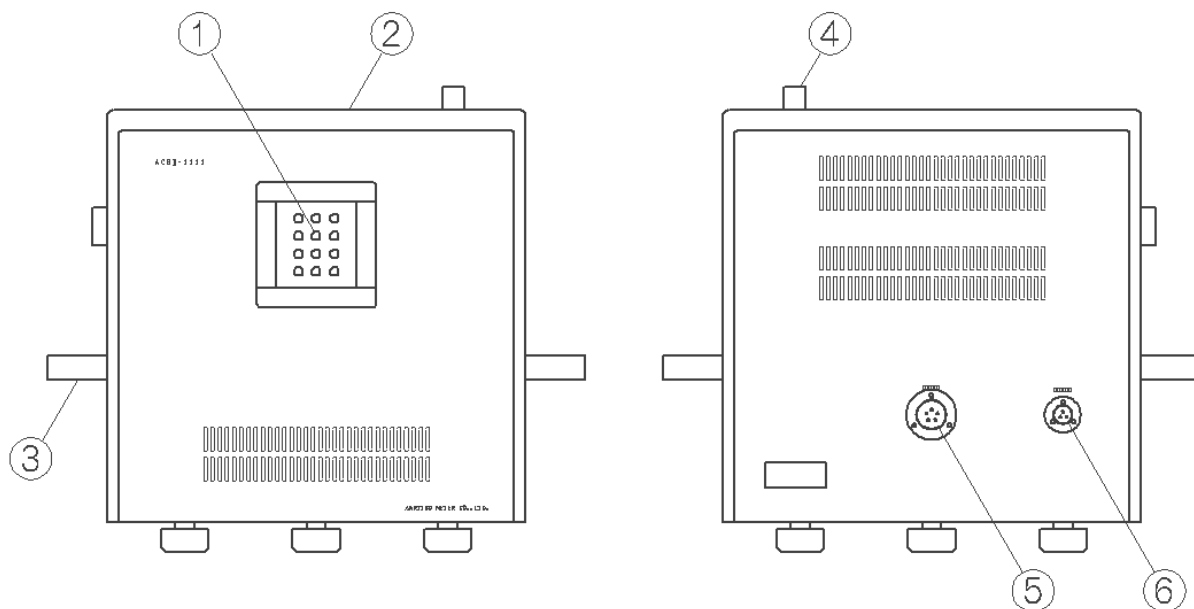

- ① Internal temperature calibration holes
- ② Surface temperature calibration surface
- ③ Grip
- ④ Heater operation lamp
- ⑤ Heater cable connector
- ⑥ Sensor cable connector

4. Preparation

4-1 Cable connections

Confirm that the controller unit power is OFF. Connect one end of the heater cable to the controller unit and the other end to the calibration block. Connect one end of the calibration block sensor cable to the controller unit and connect the other end to the calibration block, as shown in Fig. 4-1.

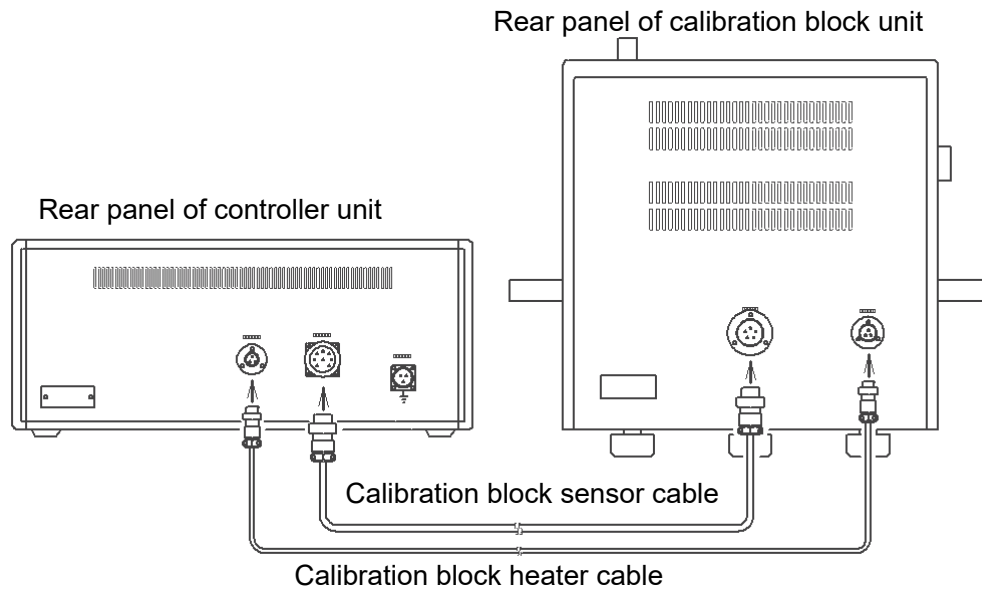

Figure 4-1

4-2 Connection of standard sensor for calibration

Connect the standard sensor (Pt100 Ω platinum resistor) used for calibration to the sensor connector located below the calibration temperature display, as shown in Fig. 4-2.

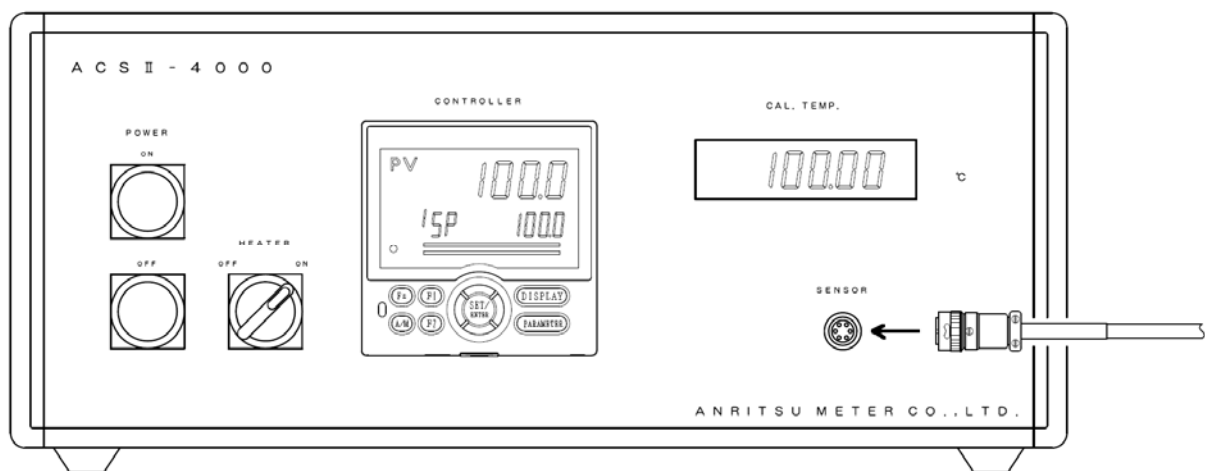

Figure 4-2

4-3 Power cord connection

Connect the power cord to the connector on the rear panel of the controller unit, as shown in Fig. 4-3.

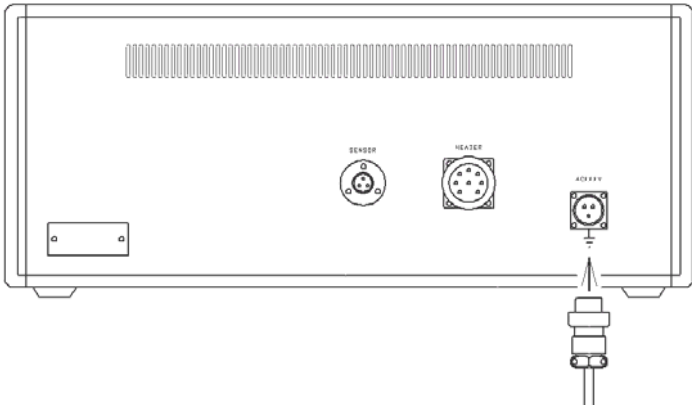

Figure 4-3

Connect the other end of the power cord directly to the AC100V power source, as shown in Fig. 4-4.

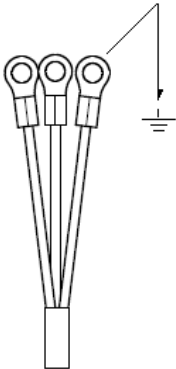

Figure 4-4

4-4 Operation Check

Turn the “POWER” switch and “HEATER” switch of the controller unit ON. The indicator of the controller unit displays the surface temperature of the block of the calibration block unit with the preset temperature below.

The green lamp at the upper left of the indicator is a heater control lamp.

When the heater switch of the controller unit is ON, it synchronizes the heater operation lamp of the calibration block unit (heater control ON).

When the heater switch is OFF, the heater operation lamp is turned off regardless of the state of the heater control lamp (heater control OFF).

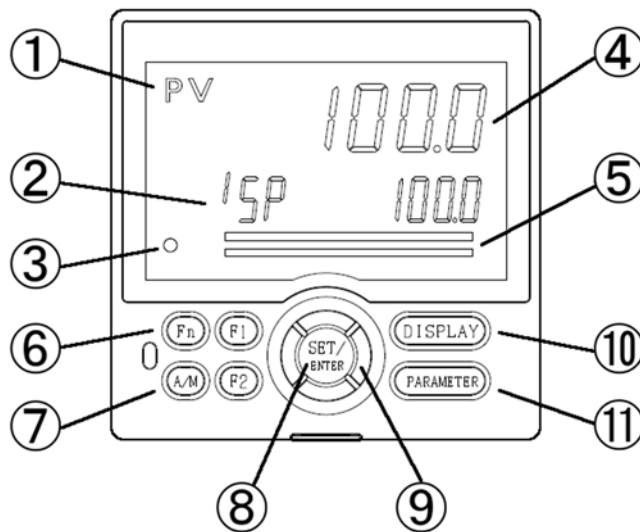

Name	Function	Name	Function
① PV	Indicated value display	⑥ Fn	PID parameter display switch key
② SP Out P (several ones)	Preset temperature display Control output display Display of various parameters	⑦ F1 F2 A/M	Not operate
③ Red luminescence	Auto tune display	⑧ SET/ENTER	Selection/ Enter key
④ Upper gauge	Indicated value level display Scale of 0 to 500°C	⑨ Arrow	Display/numeral change keys
⑤ Lower gauge	Control output level display Scale of 0 to 100%	⑩ DISPLAY	SP (preset temperature), Out (output value) Display switch key
		⑪ PARAMETER	Parameter switch key

—CAUTION—

On the controller, it is possible to manipulate parameters for temperature control (heater control) and correction of the combined sensor. Do not manipulate the internal parameters because temperature control of the calibration block may not be executed normally if some parameters are changed.

5. Operation

5-1. Turning on/off the power and heater ON and OFF

When you turn the “POWER” switch of the controller unit ON, power is applied and the indicator displays the surface temperature and the preset temperature of the calibration block as shown in Fig.5-1.

When you turn the “POWER” switch OFF, the power is turned off and the indication disappears.

When you turn the “HEATER” switch ON, the heater is heated. When the switch is turned OFF, the heater is not heated.

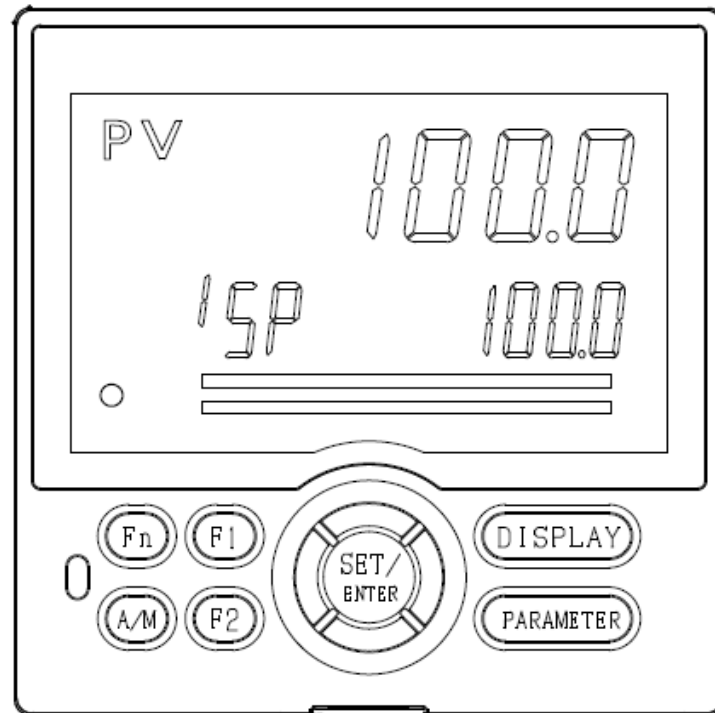

Fig.5-1.

—CAUTION—

- Be careful with the surface of the calibration block because it may be hot even after the “HEATER” switch is turned OFF.
- For power off, turn the “POWER” switch OFF when the surface temperature of the calibration block becomes low enough after the “HEATER” switch is turned OFF.
- If the power is cut off for some reasons during operation of this unit (the power code comes off and the power fails), it does not operate when the power is applied again. Turn the “POWER” switch ON again.

5-2. Temperature Control

5-2-1. setting the surface temperature of the block

The surface temperature of the calibration block is set with operation keys on the lower part of the indicator.

First, check that "SP value" is displayed on the lower row of the indicator (orange).

If an item other than "SP" (e.g. "OUT," "P" etc.) is displayed, press "DISPLAY" at the upper right of the operation keys to set "SP value."

(1) When you press the round "SET" key in the center, the value on the right of "SP" on the lower row of the indicator blinks.

(2) Change the value to a temperature you want to set by using the arrow keys in the center.

The value blinks during setting operation.

Finally, when you press the "SET" key, the value is lit and temperature setting is complete.

* When terminating the setting halfway, press the "DISPLAY" key at the upper right while the value is blinking. The normal display is returned.

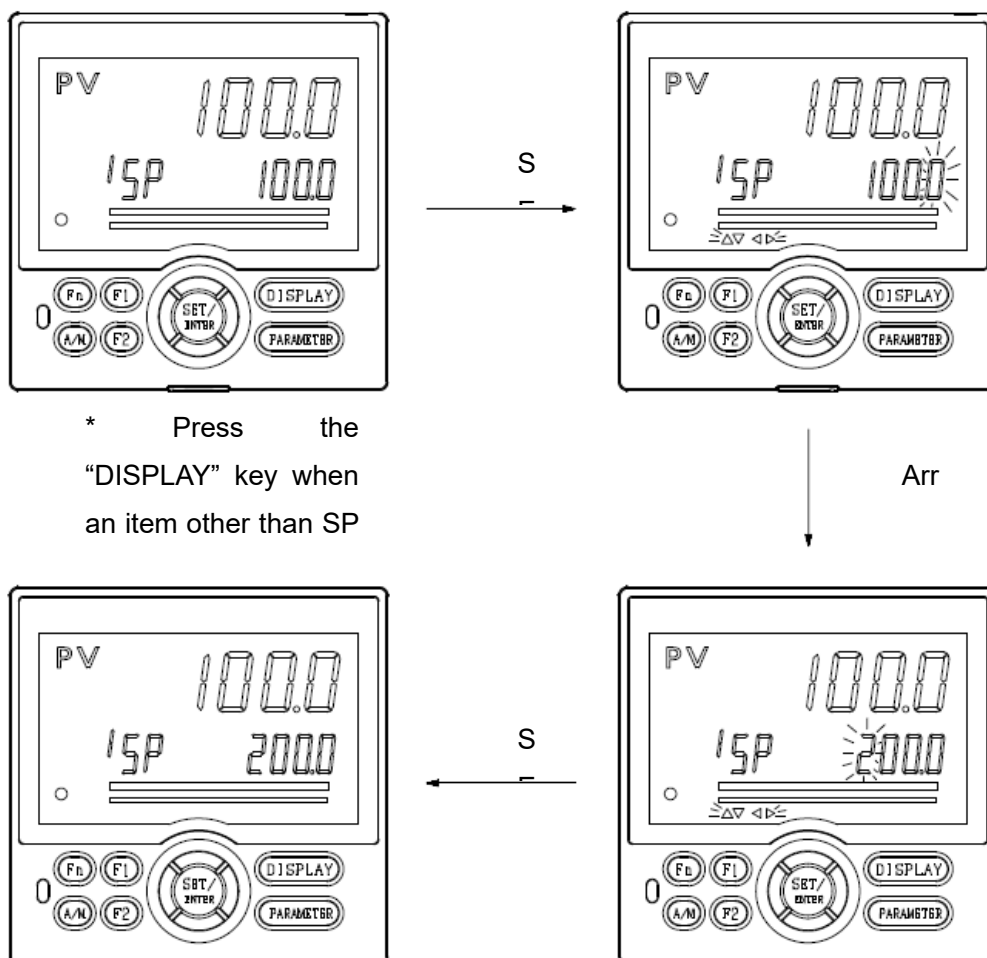

5-2-2. setting the PID values

This unit controls the temperature by PID control. There are two modes to set the PID values: auto tune mode and normal mode. Please use common auto tune mode.

- **Auto tune (Recommended mode)**

- (1) Press the long "PARAMETER" key at the lower right for three seconds. When "OPE.M MODe" is displayed on the lower row of the indicator, press the "SET" key.
- (2) When the "R.L LCL" is displayed on the lower row of the indicator, select "At OFF" with the down key of the arrow keys. When you press the "SET" key, "OFF" blinks.
- (3) Change the indication to "At 1" by using the up key of the arrow keys.
- (4) When you press the "SET" key, the lower row of the indicator is switched to "OUt 0.0". The red luminescence at the lower left blinks to start auto tune.
- (5) When the red luminescence stops blinking, auto tune is complete.

* When you want to terminate auto tune half way, cancel it by changing "At 1" in (3) to "At OFF."

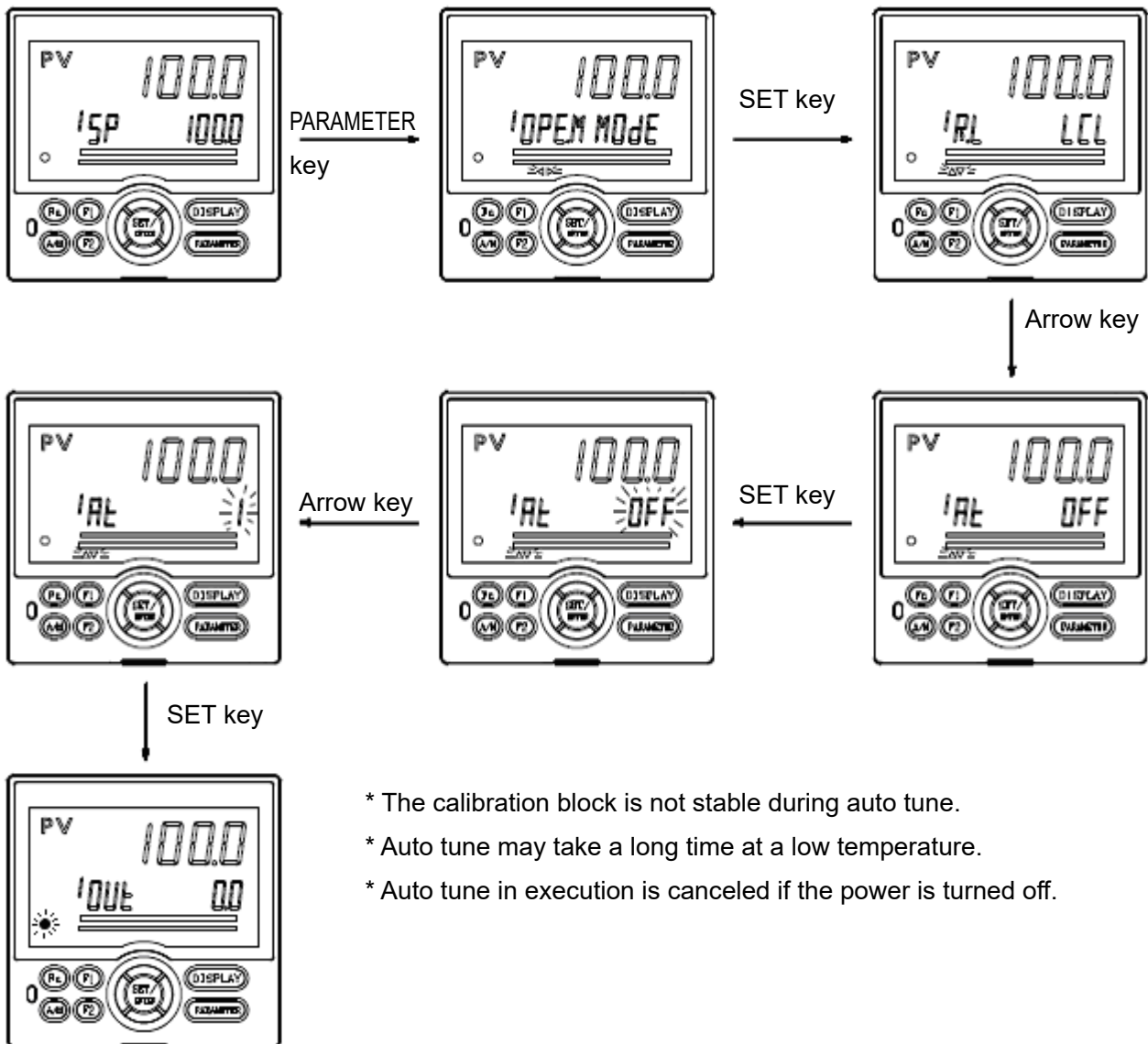

- * The calibration block is not stable during auto tune.
- * Auto tune may take a long time at a low temperature.
- * Auto tune in execution is canceled if the power is turned off.

● **Manual PID setting mode**

- (1) When you press the “Fn” key at the upper left, “P value” is displayed on the lower row of the indicator.
- (2) When you press the “SET” key, the value blinks. Then change the value by using the arrow keys.
- (3) Press the “SET” to light the value. The setting is complete.

- (4) When you press the down key of the arrow keys while “P value” on the lower row of the indicator is blinking, “P value” is changed to ”I value” and then ”D value.” Change each value by following the operation procedures (2) and (3) above.

* Do not change the values or parameters except on the P/I/D screens. See the next page.

- (5) Press the “Fn” key after the setting is complete. The normal display is returned.

* When terminating the setting halfway, press the “DISPLAY” key at the upper right while the value is blinking. The normal display is returned.

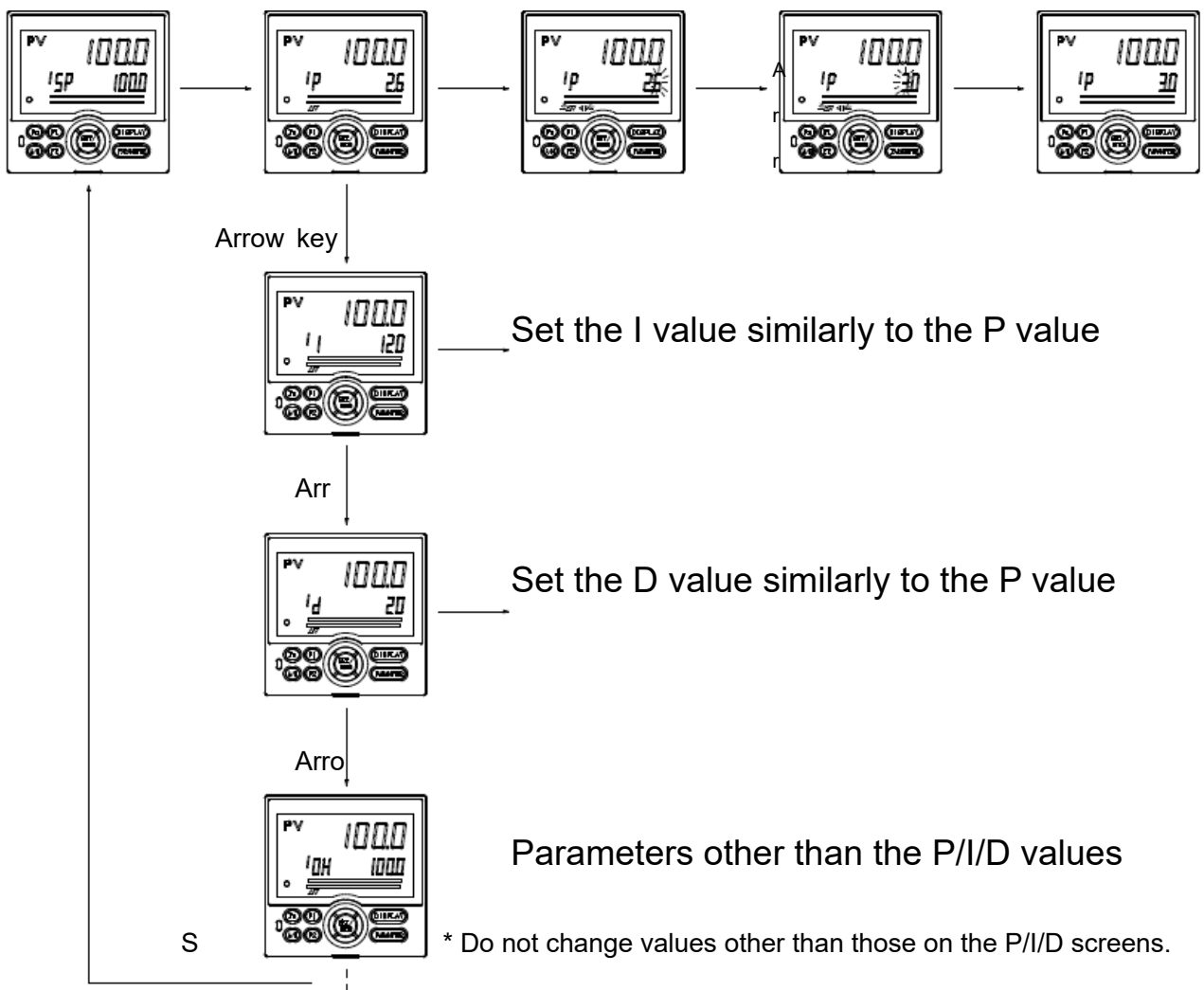

—CAUTION—

* With the operation key “Fn,” the following parameters can be changed.

When you press the “Fn” key, “P value” appears first.

The parameters are switched in turn by up/ down key operation.

“P”→“I”→“D”→“OH”→“OL” · · · “PO”→“END”→“P” (returned to the initial state)

Never change the settings other than the “P/I/D” values.

If the displayed values of parameters are different from those shown below, stop using the unit and contact us.

PID parameters switched with the Fn key and setting conditions

Parameter	Value	Description	Setting *Do not make a change.
P	2.0	Proportional band	Reference 100°C : 2.5 300°C : 2.0 500°C : 1.8
I	170	Integral time	Reference 100°C : 300 300°C : 170 500°C : 130
D	40	Derivative time	Reference 100°C : 80 300°C : 40 500°C : 30
OH	100.0	Upper limit of heating control 100.0%	*Never make a change.
OL	0.0	Lower limit of heating control 0.0%	*Never make a change.
MR	50.0	Intermediate control value 50.0%	*Never make a change.
dR	RVS	Control action (reverse action)	*Never make a change.
PO	0.0	Output at the time of stop	*Never make a change.
END	END	End	

Press the “Fn” key or “DISPLAY” key to return to the normal display.

5-3 Heating and cooling time

5-3-1 Heating time

The times required for the calibration block to reach a setting temperature after turning on the power and heater switches are listed in the table below (reference values).

	Normal mode	Auto tuning mode
Room temperature → 100°C	~ 35min	~ 50min
Room temperature → 200°C	~ 50min	~ 80min
Room temperature → 300°C	~ 80min	~ 125min
Room temperature → 400°C	~ 110min	~ 160min
Room temperature → 500°C	~ 150min	~ 210min

Room temperature: 25°C

5-3-2 Cooling time

In order to ensure that the calibration block temperature will remain very consistent, the copper block is surrounded by insulation. The time required for cooling is therefore longer than the time required for heating (reference values).

	Cooling by natural heat loss	Forced heat loss cooling*
500°C → 400°C	~ 50min	~ 30min
500°C → 300°C	~ 150min	~ 60min
500°C → 200°C	~ 300min	~ 120min
500°C → 100°C	~ 650min	~ 250min

*Using the optional heat radiating unit.

5-4 Calibration

5-4-1 Calibration method

The instrument uses a copper block with two heaters installed in the horizontal direction under the copper block.

Surface temperature calibration

The standard sensor is inserted all the way into the hole (side panel of main body) for the surface temperature calibration sensor as shown in Fig. 5-4. The sensor to be calibrated is then held perpendicularly in contact with the middle of the temperature calibration surface of the calibration block.

If the standard sensor value is taken to be T_1 and the value of the sensor to be calibrated is taken to be T_2 , $T_1 - T_2$ is the correction value to be used for the sensor being calibrated.

When the optional sensor support is used for the surface temperature sensor, it is not necessary to handle the sensor manually and highly repeatable calibration is therefore possible.

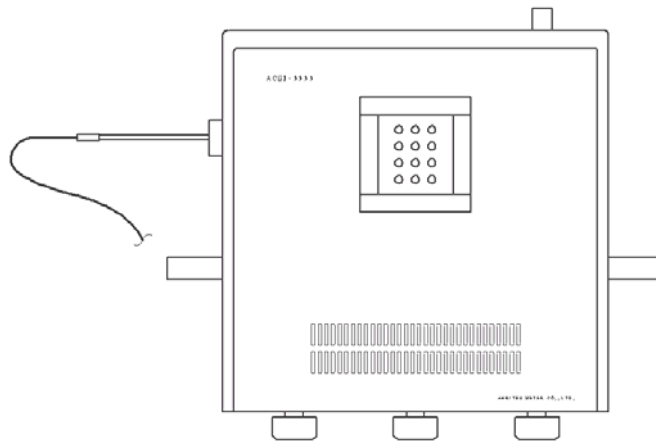
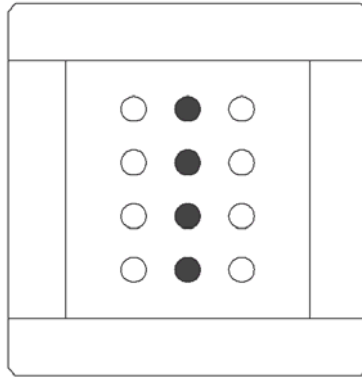

Figure 5-4

Internal temperature calibration

The calibration block has 12 sensor insertion holes as shown in Fig. 5-5. The darkened (●) holed are for the standard sensor and the blank (○) holes are for the sensor to be calibrated.

The standard sensor (Pt100Ω platinum resistor) connected to the controller unit is inserted all the way into a standard sensor hole and the sensor to be calibrated is inserted into a hole located horizontally. If the standard sensor value is taken to be T_1 and the value of the sensor to be calibrated is taken to be T_2 , then $T_1 - T_2$ is the correction value of the sensor to be calibrated.



*Sensor Insertion Holes
Figure 5-5*

5-4-2 Sensor-only calibration

When calibrating only the sensor, maintain a temperature of 0°C at the terminal of the compensation lead wire, as shown in Fig.5-6. Connect a precision digital voltage meter to the wire and read the value. Since this value is the 0°C standard electromotive force for 0°C, convert it to temperature using the JIS standard electromotive force table and calibrate.

Although 0°C is the triple point of water (ice, water, and water vapor coexist), in actual practice a small amount of water added to small pieces of ice contained in a thermos or other bottle is sufficient.

Preparation of a 0°C environment is not necessary and the values can be read directly from the display if a precision digital thermometer with cold contact point compensation is used instead of a digital voltage meter. In this case, the sensor-thermometer combination can be calibrated.

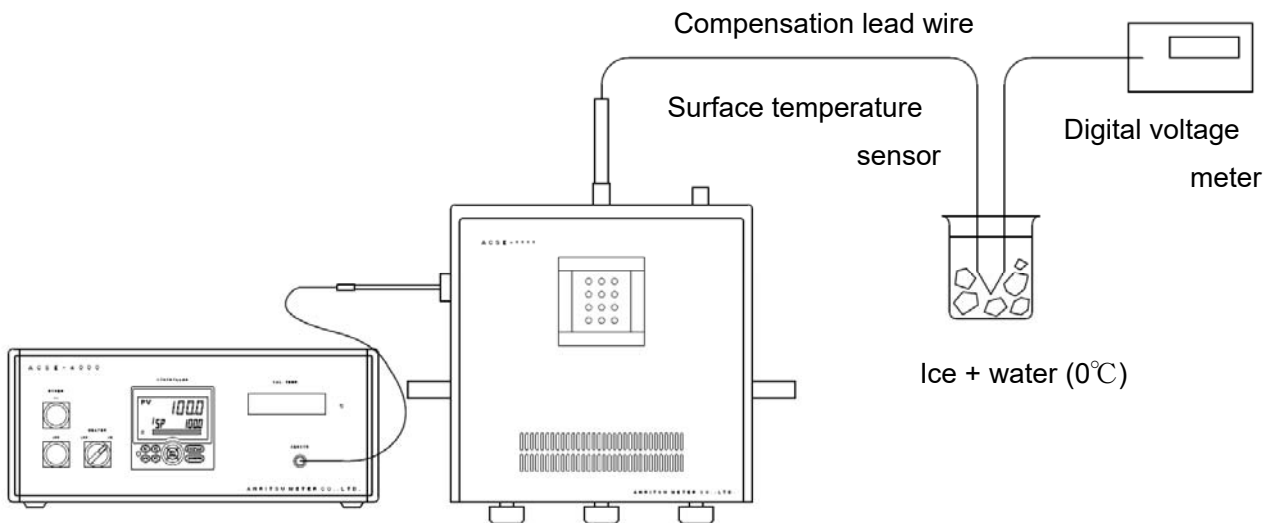
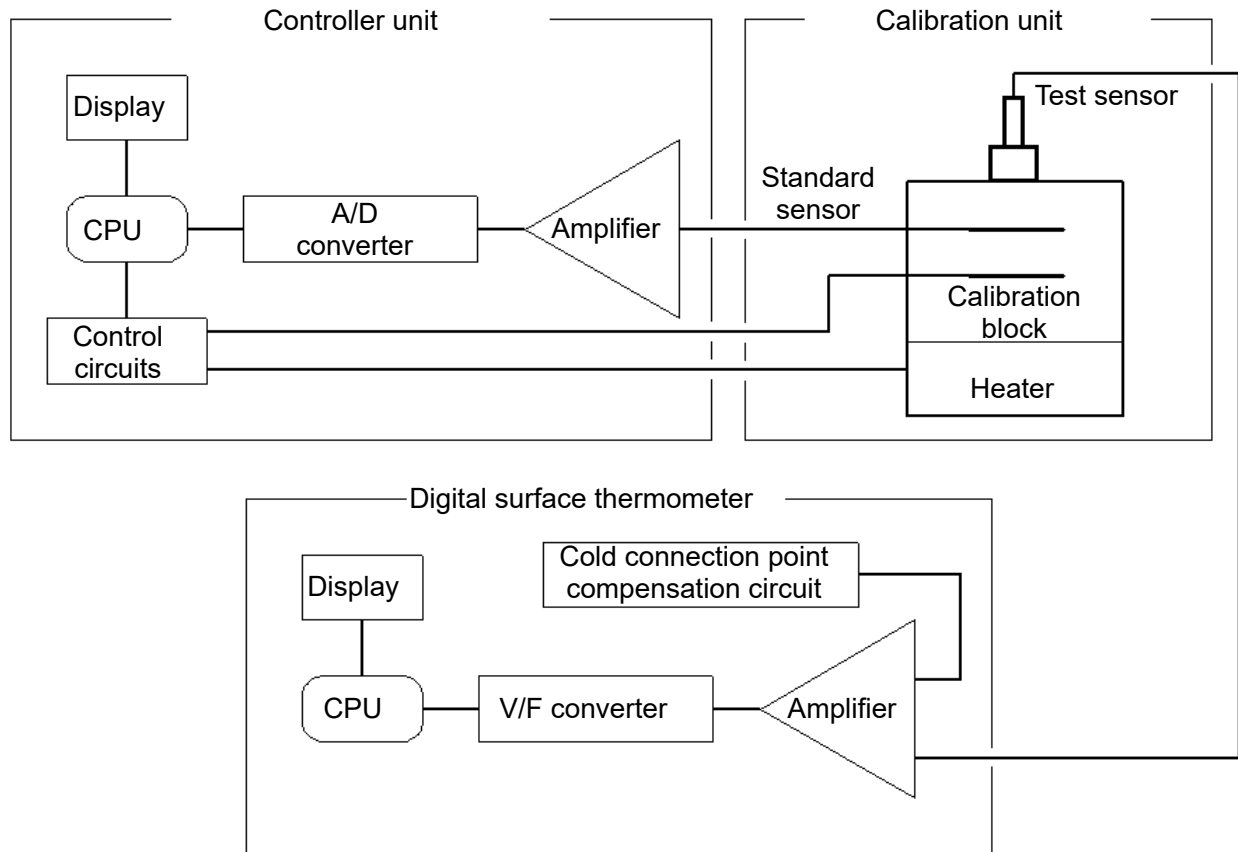

Figure 5-6

6. Explanation of Instrument Operation

6-1 System structure

The instrument consists of a controller unit and a calibration block unit. The purpose of the instrument is to calibrate surface internal temperature sensors.



6-2 Standard sensors

6-2-1 Sensor for temperature control

The sensor for temperature control is a PT100 Ω , ϕ 3.2mm, A-grade sheath-type platinum resistor. The resistance value of this platinum thermoresistor is integrated into the temperature control circuits of the controller used for high precision temperature control.

6-2-2 Standard sensor for calibration

A PT100 Ω , ϕ 4.8mm, A-grade sheath-type platinum thermoresistor is used as the standard sensor for calibration. This sensor makes high-precision calibration possible.

6-3 Surface and internal temperature distribution of the calibration block

The calibration block is 150mm square and 190mm high with a large heat capacity. Two heaters are installed horizontally under the block and the entire unit is surrounded by insulation. Heating by the heater therefore causes a heat flow in the upward direction and temperature distribution in the horizontal direction is small enough to be ignored in the calibration section. The temperature distribution is less than $\pm 0.1^{\circ}\text{C}$ in the horizontal direction at the surface as well as between the surface and internal temperature calibration sections.

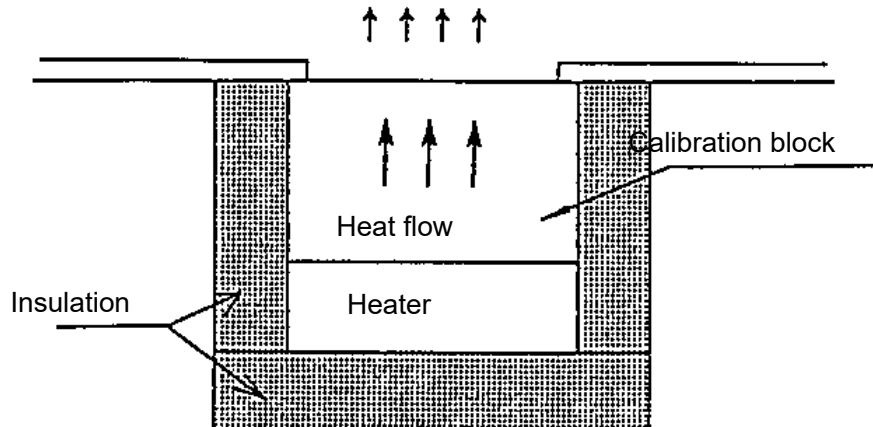

6-4 Controller

6-4-1 PID control

PID control means control by a combination of proportional operations (P), integration operations (I), and differentiation operations (D).

Operations for sending output proportional to the deviation signal are called proportional operations. Operations for sending output proportional to the integral (sum) value of the deviation signal are called integration operations. Operations for sending output proportional to the differentiated (rate of variation) value of the deviation signal are called differentiation operations. PID control combines all of these operations to provide control operations very similar to those of the human brain. Precise control is thereby obtained.

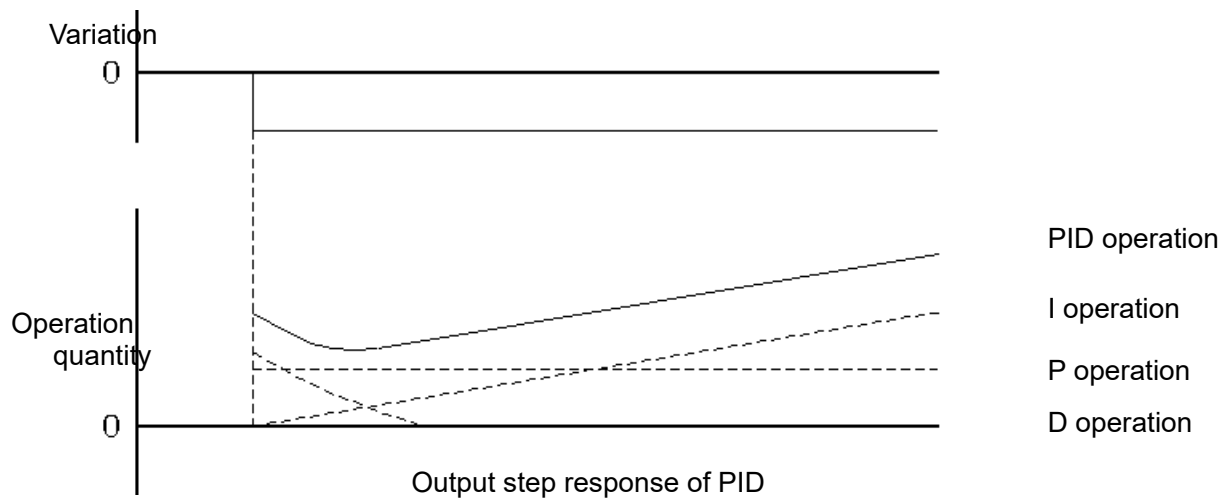

6-4-2 Auto tuning

The operation circuits installed in the controller unit measure the control characteristics of the calibration block with regard to the setting temperature and automatically determine the optimum PID value.

The following response is obtained when using control by auto tuning.

(1) When auto tuning is started during heat up:

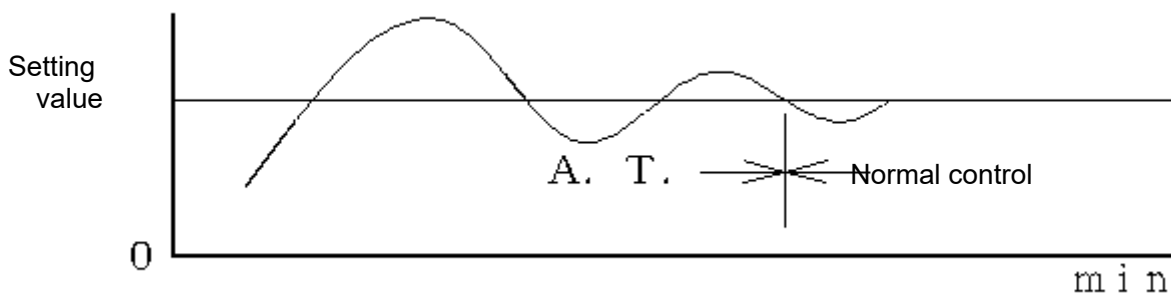

(2) When auto tuning is started during normal control:

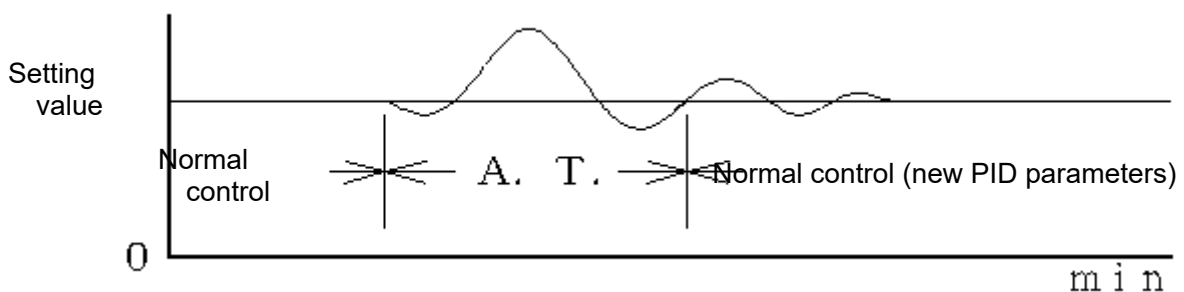

A.T.: Auto tuning control

7. Surface temperature definition and confirmation

7-1 Surface temperature definition

Substances can exist in solid, liquid, and gas phases. The temperature at which a substance nears and adheres to the solid form from the fluid forms (liquid and gas) is defined as the surface temperature of the solid.

7-2 Surface temperature confirmation

Anritsu uses the method described below to confirm the surface temperature, as defined in Section 7-1 above.

The calibration block shown in section 6-3 is prepared so that all heat flows in the upward direction.

The actual surface temperature in Fig. 7-2 is taken to be T , the internal temperature of the block is taken to be t_1 , and the surrounding air temperature is taken to be t_2 . In this case, if $t_1 > t_2$ then $t_1 > T > t_2$.

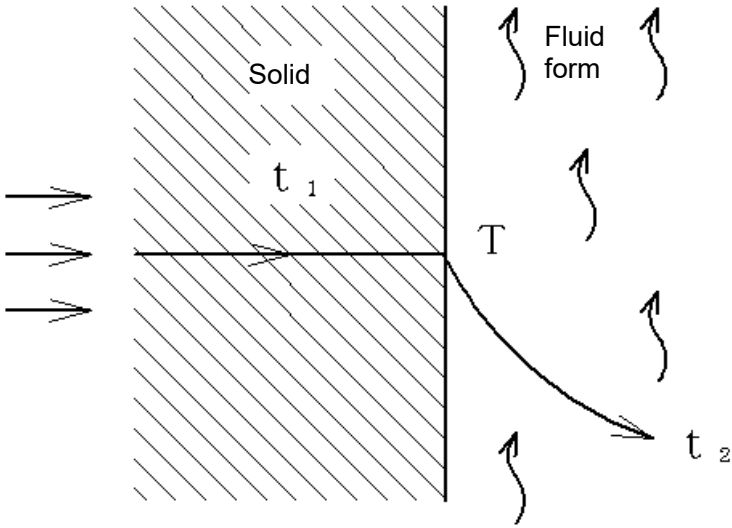
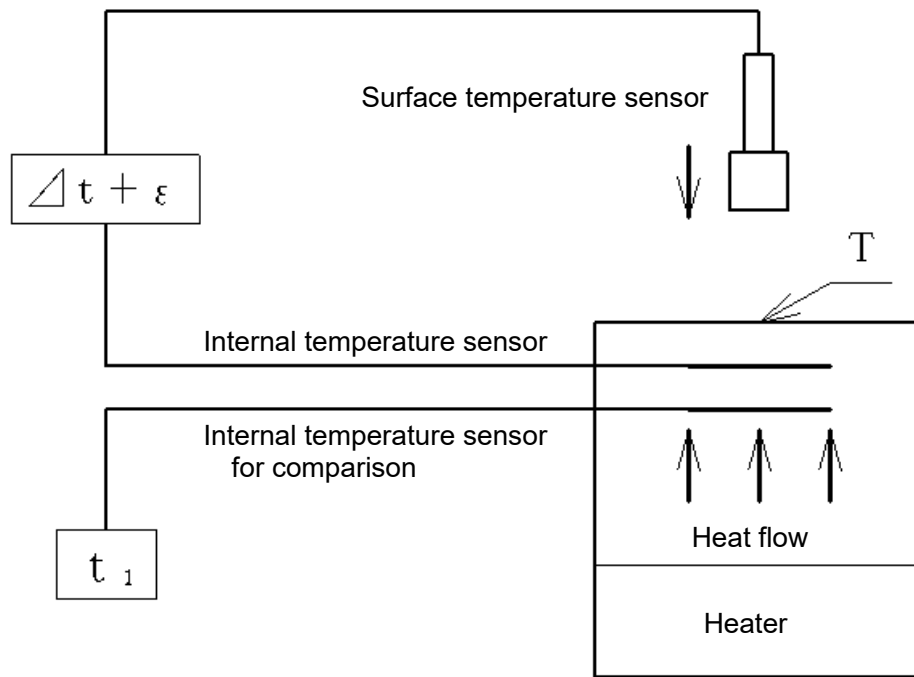

Figure 7-1

If the value at the surface temperature sensor shown in Fig. 7-2 is taken to be T' , the relationship between xx and yy becomes $t_1 > T > T'$. Here $T' = T + \epsilon$ and the temperature difference between the internal temperature and t' is $\Delta t + \epsilon$. The T temperature can be confirmed by making this temperature difference infinitely small.



$$T' = t_1 + (\Delta t + \varepsilon)$$

$\Delta t + \varepsilon$: Difference between measurement value of the surface temperature sensor and internal temperature

ε : Contact error

Figure 7-2

8. Traceability

8-1 Definition of traceability

Traceability means the equipment in use at the site can be traced back to national standards. If traceability has been established, the accuracy of the products can be guaranteed.

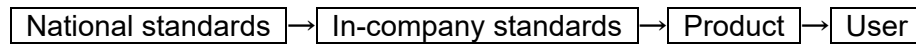

Traceability with regard to temperature is based on fixed temperature points defined in the international temperature standards (ITS-90). A management system based on this standard must exist within the company. As a leading maker of surface temperature meters, Anritsu Meter thoroughly manages standard equipment and strives to realize temperature meters that are traceable.

8-2 Traceability

Surface temperature measurement is just one of the features of the meters from the Anritsu Meter Company. However, since fixed measurement points (triple point of water, boiling point of water, solidification point of copper, etc.) are defined with respect to internal temperature and therefore cannot be applied for surface temperature applications.

Since no national standards have been specified with regard to surface temperature measurement, it is extremely difficult to evaluate measurement accuracy.

The ASC II -4000 performs an important role by providing traceability to surface temperature meters.

8-2-1 Traceability system

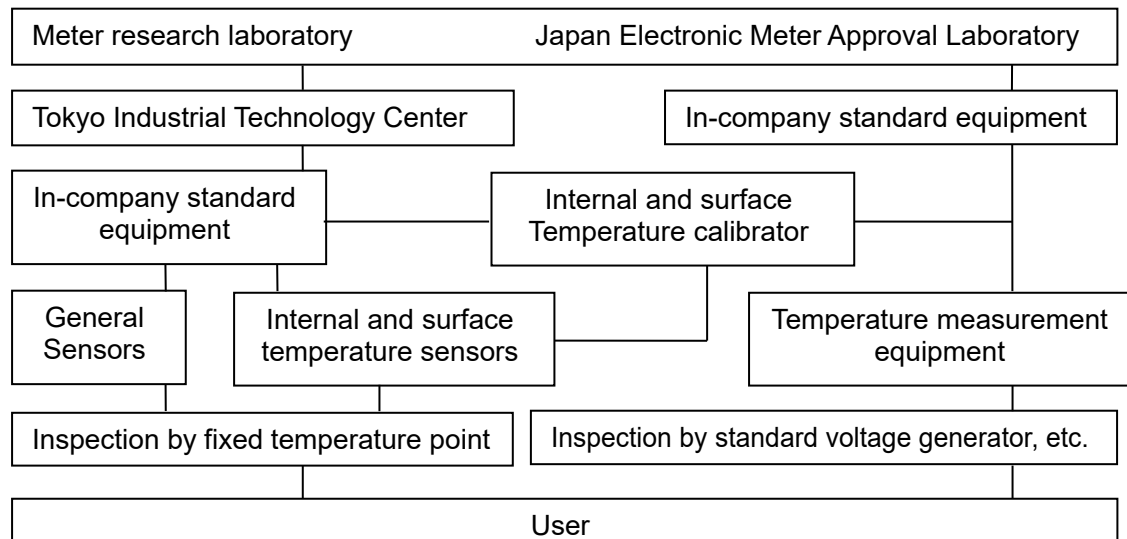

8-2-2 Traceability of surface and internal temperature calibrator

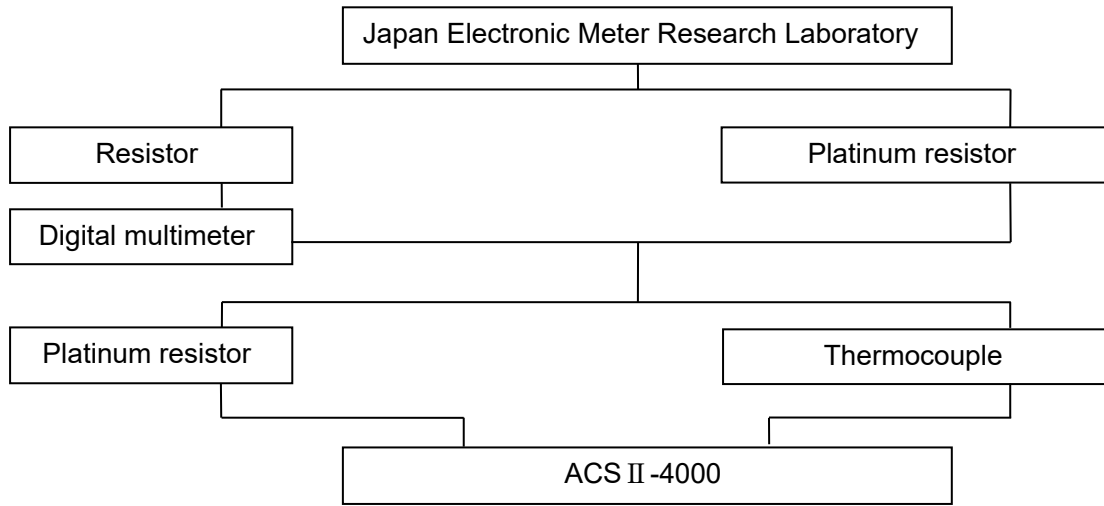

9. Basic Knowledge of Surface Temperature Measurement

9-1 Seebeck effect

When the 2 different metals, A and B, are in contact and a temperature difference exists between the metals, an electromotive force will be generated, as indicated by a potentiometer placed in the circuit.

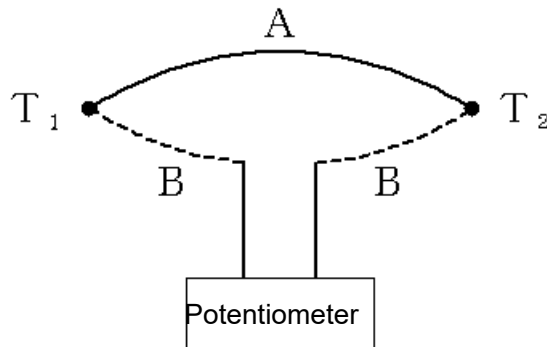

Figure 9-1

This principle is called the Seebeck effect and is generally expressed by the following formula.

$$E = a (T_2 - T_1) + b (T_2^2 - T_1^2) + c (T_2^3 - T_1^3) + \dots$$

For example, if the value of T_1 is maintained at a fixed level, E will change in accordance with fluctuations in temperature T . This is the principle underlying the operation of thermocouple thermometers.

9-2 Thermoelectromotive force characteristics

Two groups of materials are applied for use in thermocouples; the B, S, and R precious metals group, and the K, E, J, and T base metals group. A group is selected depending on the desired measurement temperature and application.

Thermocouple type		Measurement temperature (°C)
Symbol	Old symbol	
B	—	600 ~ 1700
R	PR	0 ~ 1600
S	—	0 ~ 1600
K	CA	-200 ~ 1200
E	CRC	-200 ~ 800
J	IC	0 ~ 750
T	CC	-200 ~ 350

Thermocouple – Thermoelectromotive force characteristics

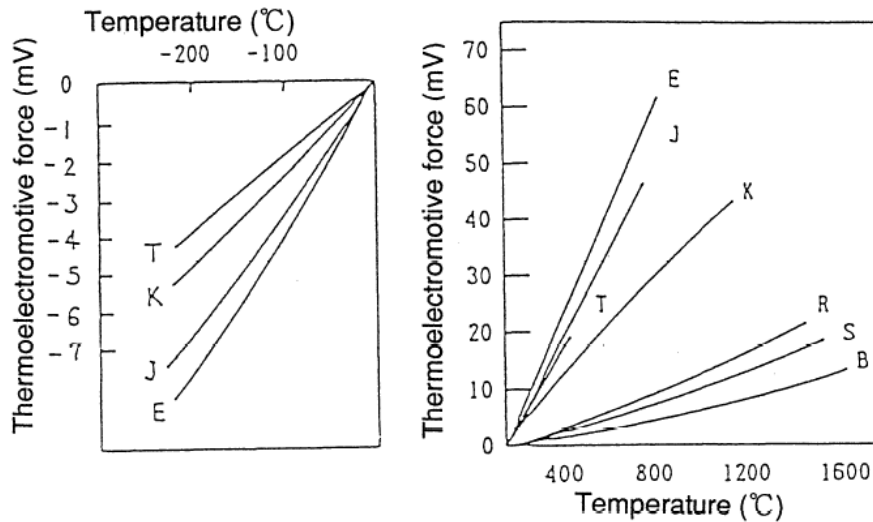

9-3 Difference between surface and internal temperatures

Internal temperature measurement may involve internal measurement of a solid or internal measurement of a liquid or gas. When measuring the internal temperature of a solid, a hole is normally made in the material and the measurement probe is inserted. However, when the measuring probe is inserted under non-strict conditions, the differences between the heat conductivity of the solid and the probe disrupt the temperature distribution and can cause an error.

A large error results when there is a large space between the hole and the probe. Insertion of a measurement probe with the smallest heat capacity possible is therefore important in order to prevent disruption of the temperature distribution. For liquids, since the heat contact with the measurement probe is good, there are no problems with regard to temperature measurement if the liquid is well stirred and a good temperature distribution is maintained.

In either of the above cases, if the insertion length of the measurement probe is more than 15 – 20 times the protective tube diameter, heat conduction error can be ignored and stable temperature measurement is possible.

For surface temperature measurement, since the boundary between a solid and liquid will be measured as shown in Fig. 9-2, care must be taken to avoid temperature distribution disruptions caused by the influence of the fluid substance or contact with the sensor.

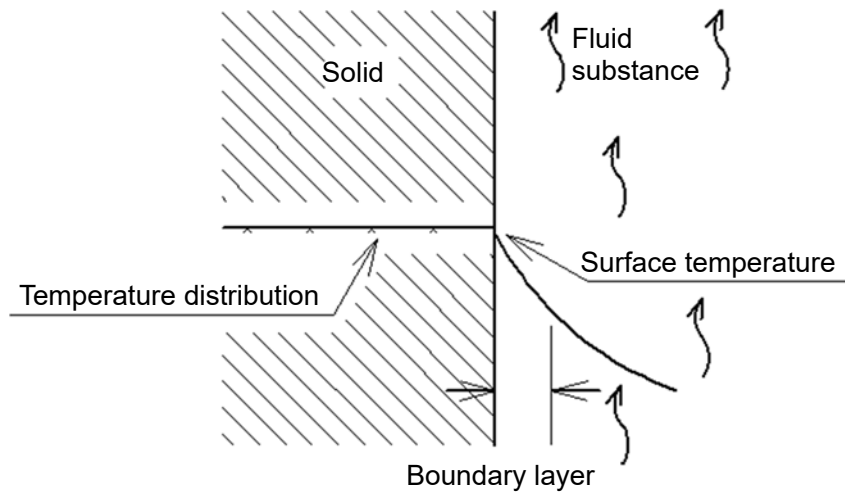

Figure 9-2

Fig. 9-3 shows the detection methods generally used for surface temperature measurement.

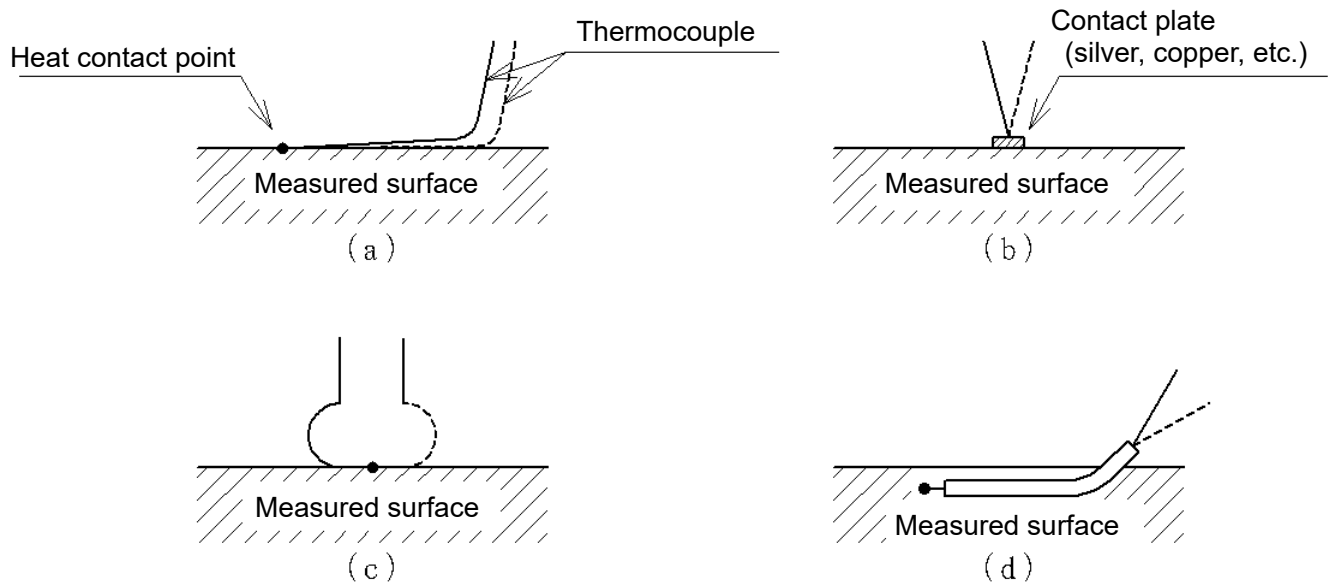

Figure 9-3

- (a) Thermocouple runs along sufficient length of surface and is secured with tape, etc.
- (b) Contact plate with good heat conduction is sealed to the surface.
- (c) Thermocouple line is shaped into a bow shape and brought directly into contact with the surface using a spring or other pressure source.
- (d) A protection tube containing a thermocouple is imbedded very close to the surface.

Although the methods have various features, method (c) is the most logical and simple from the standpoint of functionality, measurement accuracy, and response.

Most of the sensors produced by Anritsu Meter use method (c).

Surface temperature measurement requirements can be summarized as follows:

- (1) Heat capacity of the sensor itself must be small.
- (2) Sufficient thermal contact exists between the substance being measured and the sensor.
- (3) The sensor has sufficient contact area compared to its heat capacity.

10. Pointers for Accurate Calibration

10-1 Calibration environment

The instrument provides fixed points for measurement of surface and internal temperatures. In order to realize highly accurate, repeatable measurements of surface and internal temperatures, the instrument should be installed in a suitable location in the same way as other standard equipment. In particular, since the instrument is also used to create surface temperatures, choose a stable location with no air currents is best. Install the instrument as far away as possible from air conditioners and other such equipment.

Also, the sensor insertion holes and calibration block surface are the most important parts of the instrument. These parts are susceptible to fine dust. Correct calibration may not be possible if oil or other contaminants have adhered to the sensor insertion holes or calibration block surface.

10-2 Sensor handling

Be aware of the following points when handling the sensor to be calibrated.

Calibration of surface temperature sensor

Generally, with surface temperature sensors, the sensor must be perpendicular to the surface being measured. When bringing the sensor into contact with the calibration block, be sure to press the sensor onto the block at an angle of $90^\circ \pm 5^\circ$.

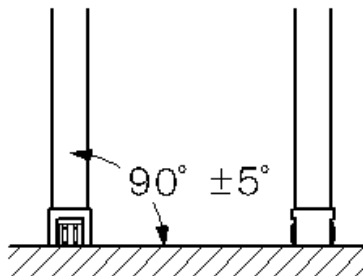

Wipe contaminants off the calibration block surface with a clear, lint-free cloth before use. Remove contaminants from the sensor itself in the same manner.

The sensor does not need to be pressed against the block with great force. Press so that the sensor contact guard lightly contacts the block.

Absolutely do not shift or move the sensor horizontally while measuring temperatures with the calibration block surface.

It is impossible to calibrate a sensor if the temperature sensing portion has been distorted, broken, or otherwise damaged. Before calibrating, confirm that the temperature sensing portion of the sensor is in the same condition as when purchased.

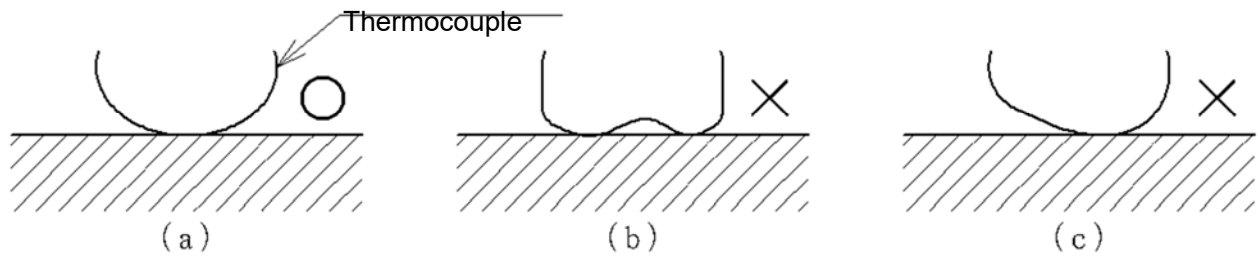

Calibration of internal temperature sensor

Wipe the sensor clean before inserting it into the instrument if oil or other contaminants are present.

In addition to making correct calibration impossible, contaminants may cause instrument breakdowns.

Insert the sensor to be calibrated into the designated insertion hole.

Generally, the internal temperature sensor must be inserted into the measurement environment to a length of 15 to 20 times the sensor diameter.

For accurate calibration, insert the sensor sufficiently into the calibration block.

11. Troubleshooting

The surface and internal temperature standard is thoroughly inspected at the time of shipping. However, if equipment operation is abnormal, check the points listed below before contacting the dealer or service center. Be sure to follow the instructions that are given.

Points to check

- Are the power cables, calibration block cables, and calibration block sensor cables correctly connected?

- If the heater switch is turned OFF and the power switch is turned ON when the calibration block is near room temperature, does a temperature close to room temperature appear on the display?

- Set the setting temperature higher than the calibration block surface temperature and turn on both the power and heater switches. Do both the green lamp at the left of the display and the heater operation lamp light at the same time?

- Is the at the temperature installation location too low or too high ($23^{\circ}\text{C} \pm 15^{\circ}\text{C}$)?

- Is the instrument installed in a location exposed to noise or vibration?

- If the problem continues after the above points have been checked, do not attempt to service the instrument. Stop using the instrument and contact Anritsu.

12. Maintenance

12-1 Storage and reuse

When not using the instrument place the upper protective cover on the calibration block unit and store in a location with a temperature of $23^{\circ}\text{C} \pm 20^{\circ}\text{C}$ and low humidity.

When using the instrument after a long period of storage, first check instrument operations (refer to chapter 4. Preparation)

12-2 Periodic return calibration

This instrument has undergone a strict inspection and when shipped is a truly reliable temperature standard. However, in order to maintain the standard's status, the following maintenance is required. In particular, since there are no surface temperature standards, some users may have concerns. In order to use the instrument with peace of mind, periodic factory re-calibration of the standard is recommended every 6 to 12 months. The calibration is carried out using the surface and internal temperature evaluator and calibration sensors at Anritsu Meter Company.

A fee is charged for the re-calibration.

12-3 On-site test service

For customers wishing to see the actual product, know more details, or actually evaluate sensors currently in use, an on-site test service is available.

Contact your nearest sales representative or service center and ask about our on-site test service.

13. Specifications

13-1 General accuracy

Setting temperature range	General accuracy	
	Surface	Internal
Room temperature ~ 100°C	+0.4°C -0.6°C	±0.26°C
100 ~ 200°C	+0.3°C -0.9°C	±0.32°C
200 ~ 300°C	+0.1°C -1.1°C	±0.37°C
300 ~ 400°C	-0.2°C -1.5°C	±0.43°C
400 ~ 500°C	-0.9°C -2.2°C	±0.48°C

Controller unit + calibration block unit + standard sensor

13-2 Controller unit

Setting temperature range	Room temperature – 500°C	
Control method	PID auto tuning (manual setting also possible)	
Controller	Input	Pt 100 Ω, φ 3.2mm, A grade
	Accuracy	0.2% of reading °C
Standard thermometer for calibration	Input	Pt 100 Ω, φ 4.8mm, A grade
	Accuracy	±(0.05 of reading + 0.05)°C
	Display	Segment
Power	100V±10%, 50/60Hz	
Maximum power consumption	About 1600W	
External dimensions	420(W) × 170(H) × 320(D)mm	
Weight	5.0kg	

13-3 Calibration block unit

Calibration block		Material: Unoxidized copper Dimensions: 150(W) × 150(D) × 190(H)mm Surface: Stainless steel, polished finish, ion plating processing Calibration surface: 150 × 150mm Calibration holes: 8 holes
Temperature distribution	Surface	±0.1°C or less
	Internal	±0.1°C or less
Heater		1500W cartridge type heater
Heating prevention structure		Bimetallic type breaker
Time to reach setting temperature	Heating	Room temperature → 250°C: 60min Room temperature → 500°C: 150min
	Natural cooling	500°C → 250°C: 220min 250°C → 50°C: 430min
	Forced cooling	500°C → 250°C: 110min 250°C → 50°C: 140min
External dimensions		450(W) × 405(H) × 400(D)mm
Weight		70kg

13-4 Accessories

Part name	Quantity
Power cord	1 (2m)
Calibration block heater cable	1 (2m)
Calibration block sensor cable	1 (2m)
Standard sensor for calibration	1
Communications cable for HL	1 (2m)
Instruction manual	1
Warranty	1

13-5 Options

Sensor holder (magnetic type)

Cooling fan (heating unit)

14. Warranty and After-Service

14-1 Warranty

All Anritsu Meter Company products undergo a strict inspection before shipping. In the event that malfunctions occur due to problems in production or accidents during shipping, contact the place of purchase or Anritsu's customer service counter.

The product is guaranteed for 1 year from the time of delivery. Breakdowns occurring during the guarantee period that are clearly the responsibility of Anritsu Meter Company will be repaired free-of-charge.

Note that breakdowns or damage caused by the following are not covered under this warranty:

- Damage caused by fire, earthquake, water disaster, or other natural calamity.
- Damage caused by improper handling, such as dropping or striking the instrument during transport.
- Damage caused by unauthorized repairs or improvements made by other than authorized service personnel (the instrument will be considered to have undergone unauthorized alterations if the case is opened, screws are loosened, etc.).
- Damage caused by improper handling and operation in violation of the instructions and cautions contained in the instruction manual.

The customer is responsible for transportation costs to Anritsu Meter Company.

The sensors of Anritsu Meter Company (detection terminals) are considered to be consumable parts and are not covered under this warranty.

14-2 After-service

If this instrument is operating poorly, read this instruction manual again. If poor performance continues, contact the place of purchase or Anritsu's customer service counter.

Repairs during the warranty period will be made based on terms and conditions expressed in the warranty. Repairs made after the warranty period will be billed depending on the nature and extent of the service(s) required.

Parts for use in repairs can be stored for up to 8 years from the time of manufacture.

When returning the instrument for periodic calibration and repair, repack the instrument, in the original case using the original shipping materials. If the original case is not available, wrap the instrument sufficiently so as to provide protection and prevent damage.

Anritsu Customer Service: