

**4-Channel Fiber Optic Thermometer
“AMOTH”**

FL-2400

User’s Manual

FHE-90037
5th edition
May 2023

Anritsu Meter Co., Ltd.



Make sure to read this user's manual to operate the temperature measuring instrument safely.

Read this user's manual thoroughly before use to ensure safe operation of this product. Keep this manual in a convenient place for future reference.



Warning

Make sure to observe the following instructions. Ignoring these may result in death or serious injury caused by fire or electrical shock.

Never use this product for purposes other than temperature measurement.

Never allow water or foreign object to enter the product.

- This may cause fire, electrical shock or product failure.
- Contact the distributor or Anritsu Meter for repair if water or foreign object caused product failure.

Never try to disassemble or modify the product.

- This may result in personnel injury caused by fire, electrical shock or abnormal behavior of the product.
- Contact the distributor or Anritsu Meter to check or repair inside the product.

Ensure correct polarity for battery.

- Incorrect polarity may cause fire, damage or product failure.
- In case battery leakage occurs, contact the distributor or Anritsu Meter for repair.



Caution

Make sure to observe the following instructions. If not, injury or damage to peripheral equipment may be caused.

Do not touch the power plug with wet hands.

- This may cause electrical shock.

Install the product on a stable surface.

- Avoid installing the product on an unstable table or inclined surface. The product may fall and cause personnel injury.

Arrange cables properly.

- Tripping over the power cable or sensor cable for temperature measurement may cause the product to fall or topple, and lead to personnel injury. Careful arrangement of cables is necessary.

Preface

Thank you for purchasing the Anritsu Meter product.

This user's manual is provided to ensure correct operation of our product.

Please read this manual thoroughly and familiarize yourself with each function of the product before use.



Caution

This instrument uses blue light for temperature measurement.

The blue light may be emitted to outside if the sensor is not connected or the sensor is damaged.

In this case, avoid looking at the blue light directly for a long time. Doing so may cause eye strain or visual loss.

Warranty

Our products are carefully inspected before shipment. However, if the product arrives defective due to manufacturing faults or mishandling during transportation, contact your distributor or Anritsu Meter.

Our products are warranted for one year from the date of delivery. Failure occurred within the warranty period will be repaired with no charge, provided that the failure is attributable to Anritsu Meter.

Please note that the following cases will not be covered by this warranty in any circumstances.

- Failure resulting from natural disaster such as fire and earthquake.
- Failure caused by misuse, inappropriate handling or modification.

(Opening case or loosening screws is regarded as a modification.)

After-sales service

If you feel the instrument is not working well, consult this manual to examine the cause of the problem.

If it does not help improve the situation, contact your distributor or Anritsu Meter.

Repairs within the warranty period are accepted according to the contents in the warranty card.

After the warranty period expires, we will repair the product at the customer's expense if the repair is expected to improve and maintain the product performance.

When you are to return the product to Anritsu Meter for repair or periodic calibration, reuse the case and packing material originally used. If it is not possible, wrap the product with appropriate cushioning material to prevent any damage to the product during transportation.

Caution

- Use the specified fiber sensor only.
- Reprinting this manual in whole or in part without permission is prohibited.
- Every effort has been made to ensure that the information in this manual is accurate. However, if any important information is omitted or any doubts or error is found in this manual, please contact us or the distributor.
- We assume no responsibility for any results obtained by the use of this product.
- The contents of this manual or specifications of this product are subject to change without notice.
- **Avoid installing the instrument and interface cable where it may be affected by electromagnetic noise.**

Table of Contents

1. Product Name	1
2. Product Model	1
3. Product Overview.....	1
4. Packing	1
4.1 Unpacking	1
4.2 Repacking.....	1
5. Part Names and Functions	2
5.1 Outer Appearance	2
5.2 Part Names and Functions	3
6. Operation	5
6.1 Preparation of Operation	5
6.1.1 Connecting Sensor	5
6.1.2 Fuse.....	5
6.1.3 Connecting Power Cable	6
6.1.4 Connecting Power Cable to Outlet	6
6.2 Operating Instructions	7
6.2.1 Channel Setup (Setting measurement ON/OFF channels)	7
6.2.2 Start/Stop Measurement.....	8
6.2.3 Calibration	8
6.2.4 RS-232C Communication.....	13
6.2.5 Analog Output	14
6.2.6 Error Display and Remedies	15
7. Maintenance.....	16
7.1 Storing the Product.....	16
7.2 Cleaning Case.....	16
7.3 Relocation.....	16
8. Specifications.....	17
9. Warranty	19

1. Product Name 4-Channel FiberOptic Thermometer

2. Product Model FL-2400

3. Product Overview

This instrument is a temperature measurement instrument designed to obtain temperature data by measuring the variation in fluorescence decay time of fluorescent material as temperature changes using optical fiber.

Since this instrument uses light for measurement, it enables temperature measurement of high-frequency microwave field, magnetic field, high-voltage/high-current applied material or explosive material, which is difficult to measure accurately with conventional methods.

Also, this instrument is equipped with RS-232C communication function and analog output function. These functions offer you various uses of temperature data by transporting them to your computer, including drawing graphs, creating records and connecting to a recorder.

4. Packing

4.1 Unpacking

When unpacking the product, check if all the following items are included. The product is carefully packed before shipment, however if any item is excluded or damaged, or if any error or incompleteness is found in the warranty card, please contact your distributor or Anritsu Meter.

Please keep the warranty card in a safe place. Without it you may not be able to receive charge-free repair service during the warranty period.

Item	Qty
Main unit	1
Power cable (two-wire plug attached)	1
Fuse (2A mini fuse)	1
Analog output cable	4
Communication cable	1
USB-RS-232C Converter	1
PC software (CD ROM)	1
User's manual (for main unit and software)	1 copy each

4.2 Repacking

When moving this product (transport to another location or carry by car), reuse the originally used case and packing material. If it is not possible, wrap the product with appropriate cushioning material to prevent any damage to the product.

Use a dry, dust-free packing material since dust or moisture could damage the product.

5. Part Names and Functions

5.1 Outer Appearance

Front side

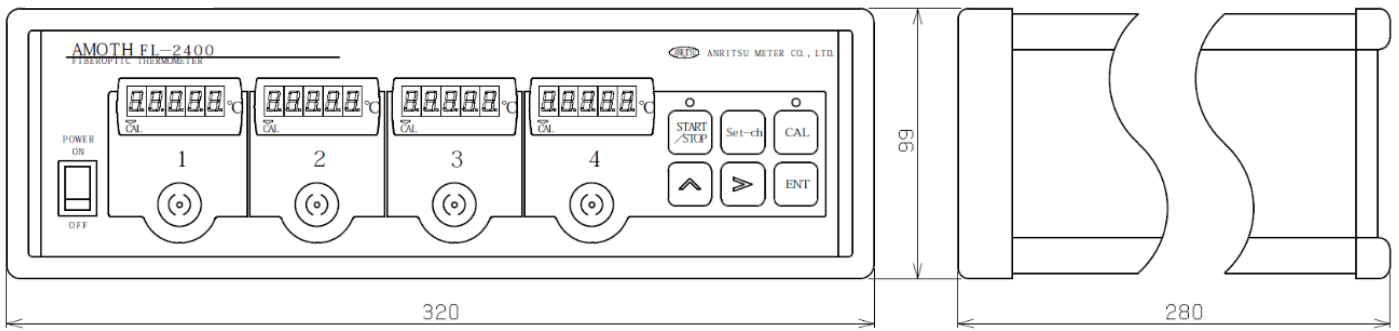

Rear side

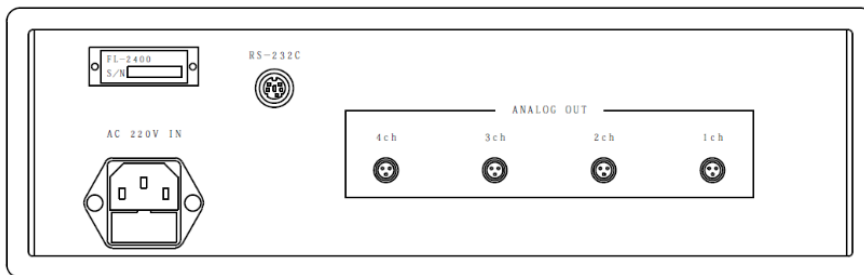

5.2 Part Names and Functions

<Front side>

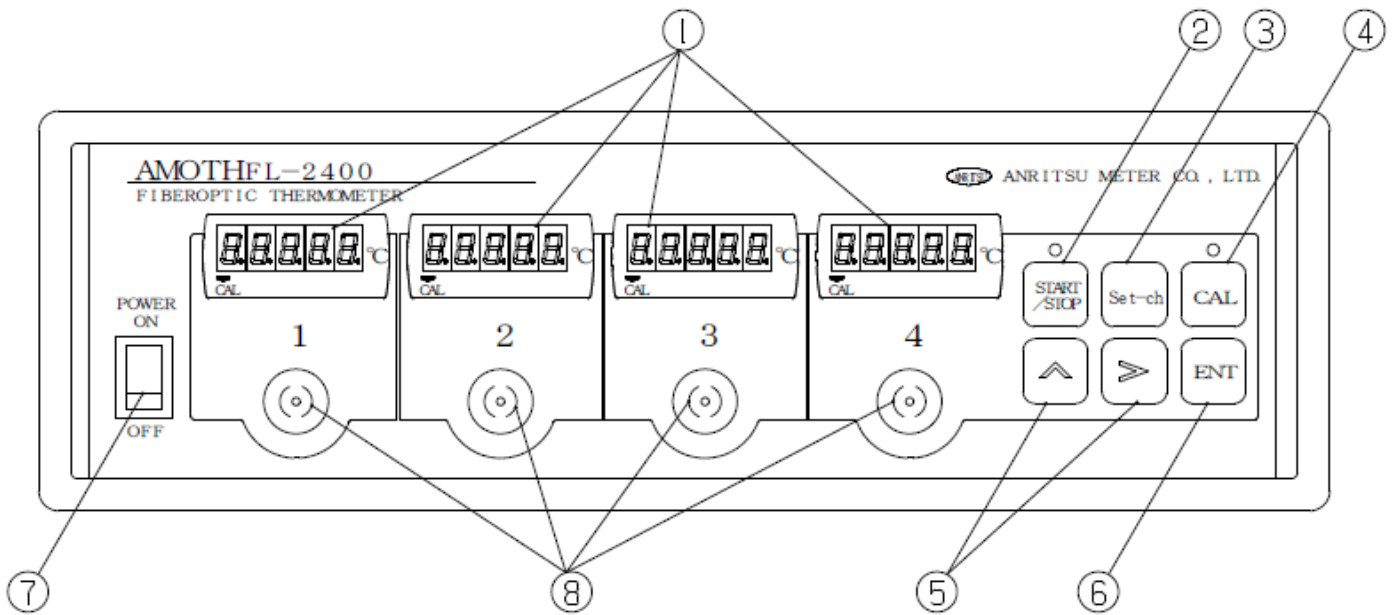

① Display

Indicates measured data, calibration temperature and measurement error.



② Start/Stop key (START/STOP)

Starts or stops temperature measurement on all ON channels.

③ Set-Channel key (Set-ch)

Sets individual channels to ON/OFF to enable/disable temperature measurement.

④ Calibration key (CAL)

Sets calibration temperature and executes/cancels calibration.

⑤ Cursor key (← →)

Use the cursor keys for ON/OFF channel setup and calibration setup.

⑥ Enter key (ENT)

Determines a value made with the cursor key.

⑦ Power switch (POWER)

Turns ON/OFF the power.

⑧ Sensor connector (SENSOR)

Connects a fiber optic sensor (FS series).

<Rear side>

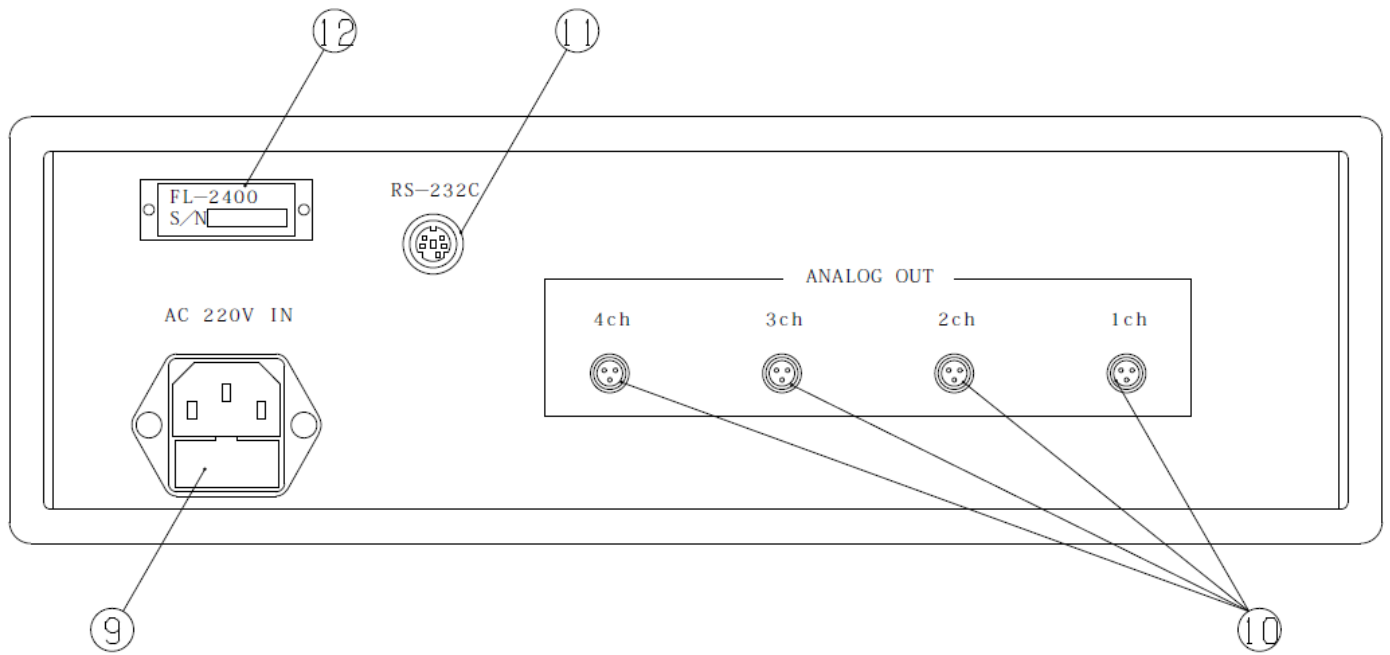

⑨ **220V AC power connector** (fuse holder attached)

Connects a 220V AC power connector with ground terminal. The upper holder contains 2A mini fuse.

⑩ **Analog output connector** (ANALOG OUT)

Outputs 10 mV voltage per 1°C for each channel. Using the provided analog output cable, you can connect the instrument to a voltage recorder.

⑪ **Connector for communication connection** (RS-232C)

Connect the provided communication cable to communicate with a personal computer.

Using the PC software provided, you can start or stop the instrument from a computer and obtain real-time measurement data.

⑫ **Product nameplate**

Indicates the product name and serial number.

6. Operation

6.1 Preparation of Operation

Connect the peripherals as described below to operate this instrument.

6.1.1 Connecting Sensor

Connect a temperature sensor to the sensor connector (SENSOR) on the front side of the instrument as shown below. At this time, align the protrusion of the sensor with the indentation in the sensor connector of the instrument, and then rotate the key ring until it stops to connect the sensor to the instrument.

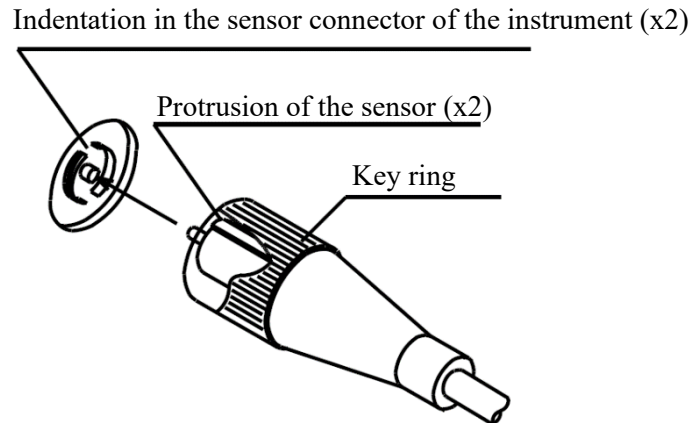

NOTE

- Use the specified temperature sensor only.

Using a sensor other than the specified sensor cannot provide accurate measurement and it may damage the instrument.

6.1.2 Fuse

The fuse holder located on the rear side of the instrument contains 2A mini fuse. Pull out the fuse holder as shown below and check if 2A mini fuse is attached.

⚠ Caution **Make sure to remove power cable before pulling out fuse holder.**

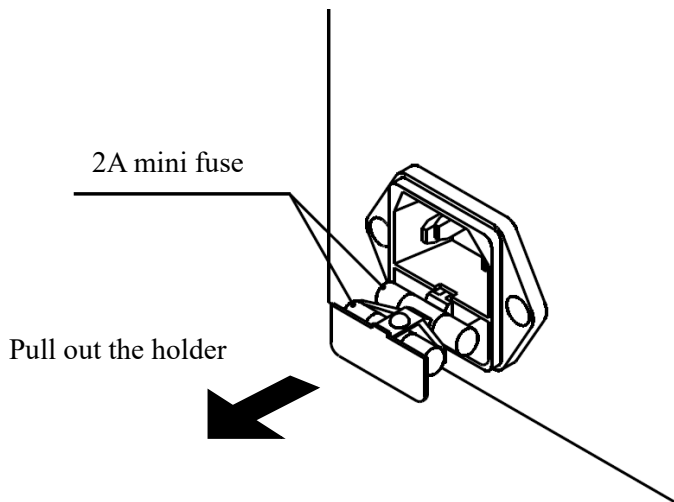

6.1.3 Connecting Power Cable

As shown in the figure below, connect the power cable to the 100V AC power connector on the rear side of the instrument.

⚠ Caution **Make sure to power OFF before connecting.**

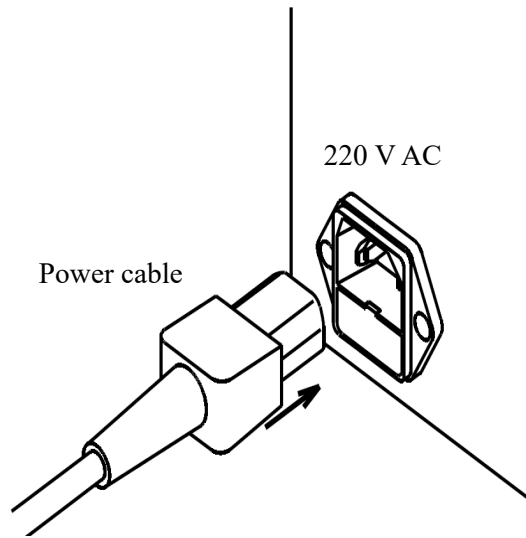

6.1.4 Connecting Power Cable to Outlet

Connect the power cable plug to the outlet.

A two-wire adapter is attached to the power cable. To use this, make sure to connect a ground wire to the ground terminal. When the two-wire adapter is removed, the cable can be connected to the outlet for three wires.

⚠ Caution **Make sure to power OFF before connecting.**

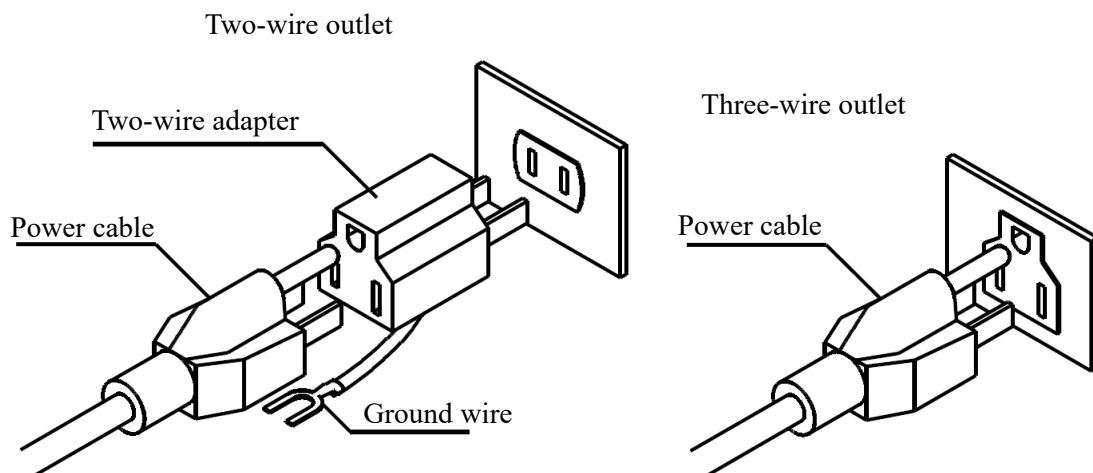

6.2 Operating Instructions

6.2.1 Channel Setup (Setting measurement ON/OFF channels)

When the preparation of operation is completed, turn on the power switch.

If “Err.” is displayed upon power-on, it means a communication error has occurred. Turn the power OFF then turn it ON again.

After LED on the display blink for a few seconds, the instrument goes to the measurement standby mode.

In the measurement standby mode, the display shows the measurement ON/OFF status of each channel. ON (ON) means measurement is enabled for this channel and OFF (OFF) means measurement is inactive for this channel.

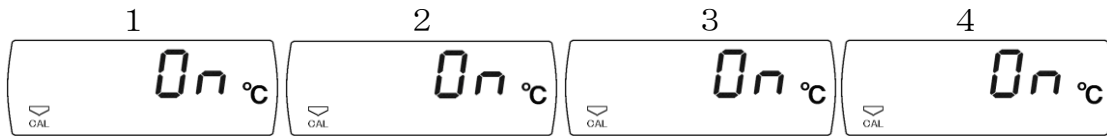

In the measurement standby mode, press the Set-ch key. The channel 1 display blinks.

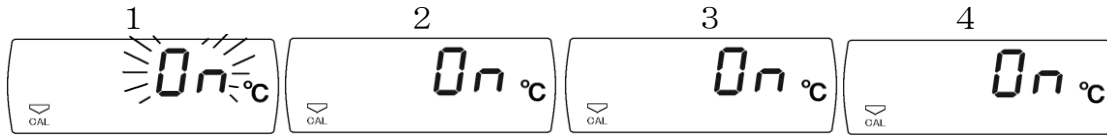

To change the channel, press the \Rightarrow key. The next channel display blinks.

Pressing the key repeatedly will cycle through the channels in this order: 1ch \rightarrow 2ch \rightarrow 3ch \rightarrow 4ch \rightarrow 1ch...

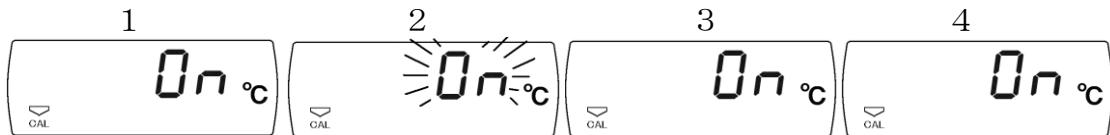

Use the \wedge key to switch between ON (ON) and OFF (OFF).

Select OFF for channel(s) to be deactivated for measurement.

Each time the \wedge key is pressed, the channel status switches as follows: ON \rightarrow OFF \rightarrow ON...

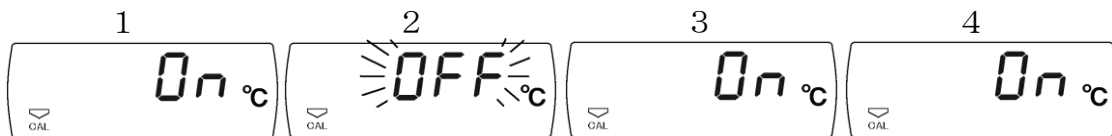

Press the ENT key to confirm your settings. All channel displays will change from blinking to solid light. This will complete the channel measurement ON/OFF setup.

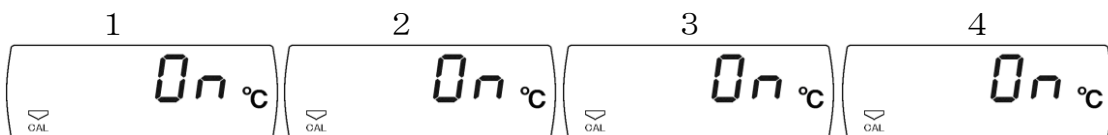

6.2.2 Start/Stop Measurement

In the measurement standby mode, press the START/STOP key to start measurement on channels set to ON. Measured values are indicated on the corresponding displays.

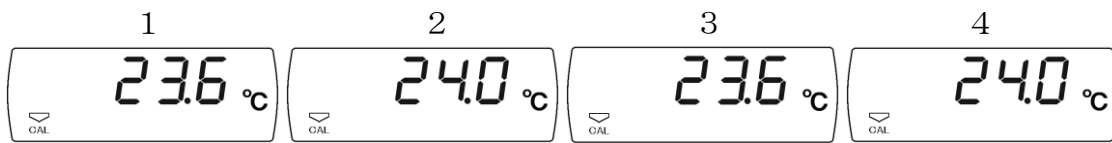

When the START/STOP key is pressed during measurement, the measurement stops and the instrument goes to the measurement standby mode.

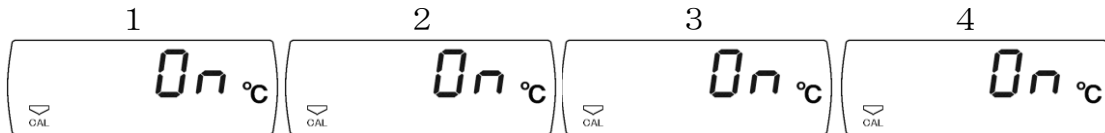

If “Err”, “OL” or “-OL” is indicated on the display during measurement, it indicates measurement error. See 6.2.7 Error Display and Remedies.

6.2.3 Calibration

For normal measurement, this instrument offers an accuracy of $\pm 2^{\circ}\text{C}$. However, when you need more accurate measurement, use the calibration function.

When calibration is executed, an accuracy of $\pm 0.5^{\circ}\text{C}$ can be obtained within a range of up to 50°C above or below the calibration point.

This instrument actually measures a real temperature for a standard value, and calculates the difference between a measured value and a true value (calibration set value), converting the difference into decay time then adding for calibration.

Therefore, for accurate calibration, real temperature within a measured area and standard thermometer for obtaining accurate standard temperature are necessary.

(We recommend you to use a temperature calibrator for calibration.)

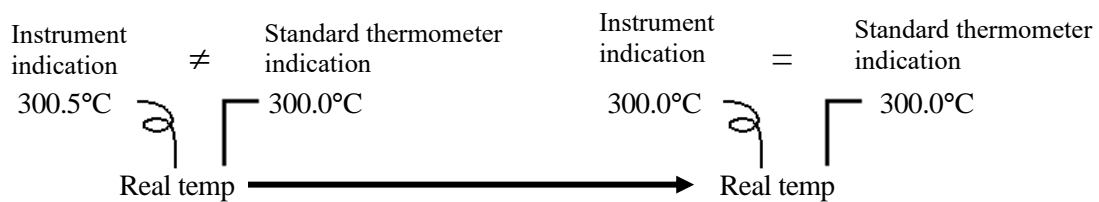

Executing calibration with a set value of 300.0°C

NOTE

- Never change the sensor while executing calibration. Variability between sensors may decrease the accuracy.

(1) Setting calibration temperature

To set the calibration temperature, press the **CAL** key while the instrument is in the measurement standby mode.

The instrument goes to the calibration temperature setup mode. Calibration values can be set individually for each channel.

Press the CAL key. The display shows “ \llcorner Ir” (clear) or previously set value, and the channel 1 display blinks. (To cancel the calibration, set all channels to “ \llcorner Ir”.)

Each time the \wedge key is pressed, the display cycles through the values in this order: \llcorner Ir \rightarrow -000.0 \rightarrow 0000.0 \rightarrow \llcorner Ir...

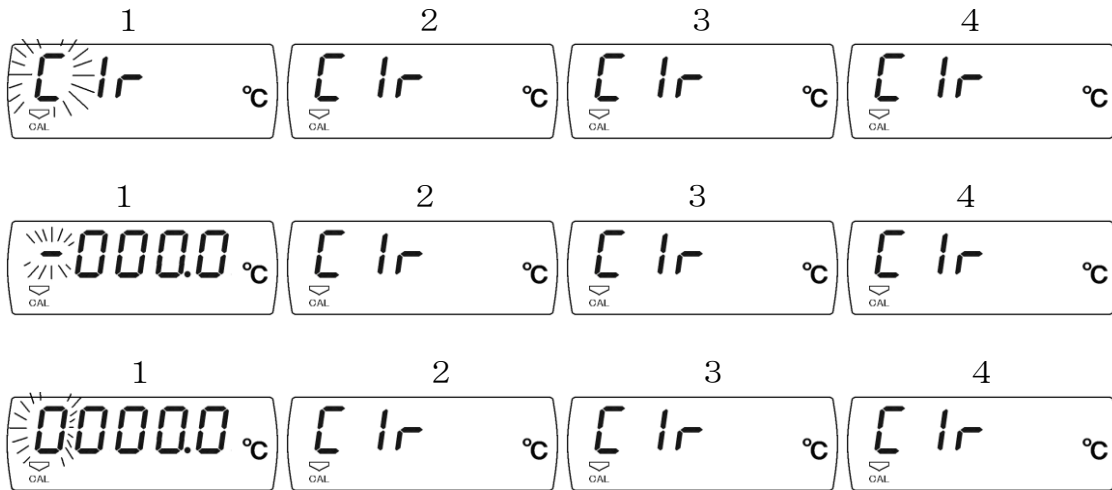

When “-000.0” or “0000.0” is displayed, press the \Rightarrow key to move between digits.

On any digit other than the uppermost digit (on second or subsequent digit), press the \wedge key to cycle through values as follows: 0 \rightarrow 1 \rightarrow 2 \rightarrow ... \rightarrow 8 \rightarrow 9 \rightarrow 0 \rightarrow 1

To change the channel, press the \Rightarrow key once when “ \llcorner Ir” is displayed, or press the \Rightarrow key 5 times when “-000.0” or “0000.0” is displayed.

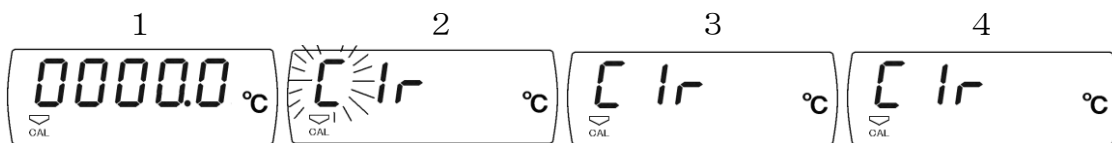

Press the ENT key to confirm your settings. Each channel display goes to the measurement standby mode.

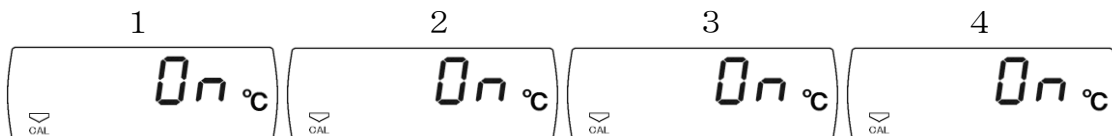

***Calibration cannot be performed for channels set to measurement OFF status. Set the measurement status to ON before setting calibration.**

(2) Executing calibration

Press the CAL key during measurement. Calibration can be performed for one channel at a time or all channels simultaneously.

- To perform calibration for any one channel:

Press the START/STOP key to start measurement.

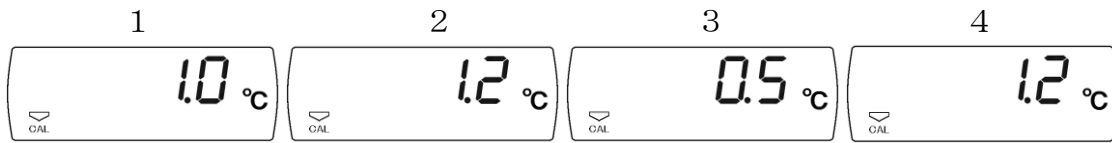

Press the CAL key. The channel 1 display indicates the calibration value set for the channel 1 and blinks. (All other channel displays show their calibration values with a solid display.)

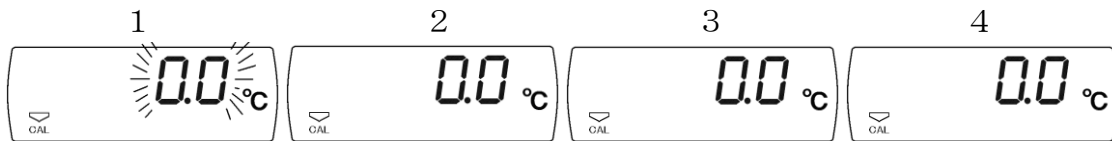

Press the ENT key to perform calibration for channel 1 only. The CAL LED is lit indicating that calibration is in progress.

* Calibration should be performed when the temperature reading is stable.

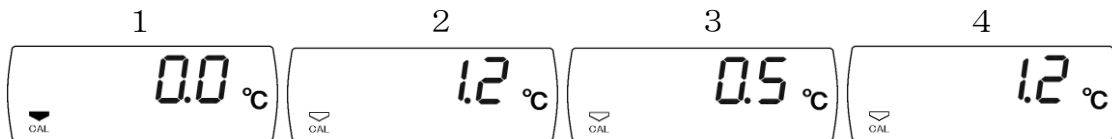

- To perform calibration for all channels at the same time:

Press the START/STOP key to start measurement.

Press the CAL key. The channel 1 display indicates the calibration value set for channel 1 and blinks. (All other channel displays show their calibration values with a solid display.)

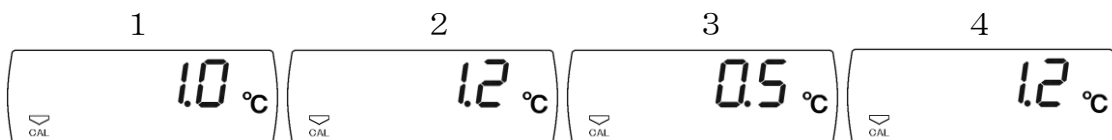

Press the \Rightarrow key to change the channel for which calibration is performed.

Pressing the key repeatedly will cycle through the channels as follows: 1ch \rightarrow 2ch \rightarrow 3ch \rightarrow 4ch \rightarrow All ch \rightarrow 1ch...

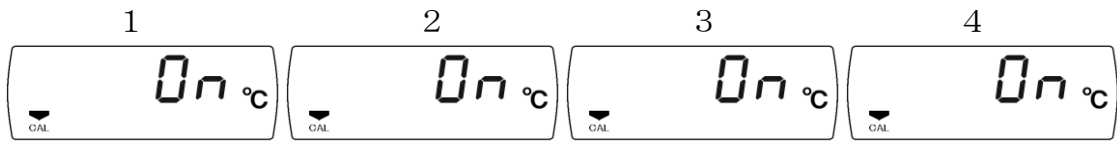

:

Press the \Rightarrow key 4 times.

:

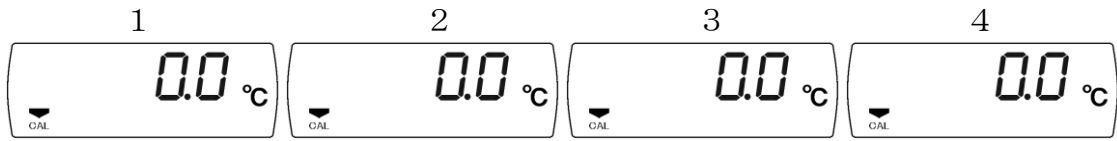

When all channel displays are blinking, press the ENT key to perform calibration for all channels simultaneously.

*Calibration should be performed when the temperature reading is stable.

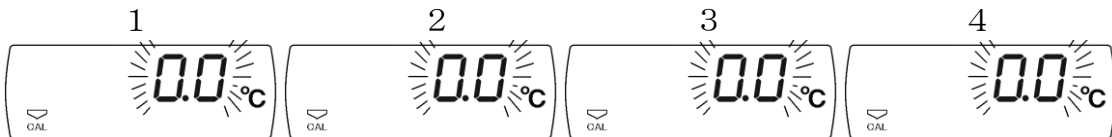

The CAL LED remains lit in the standby mode for the channels being calibrated indicating that calibration is in progress.

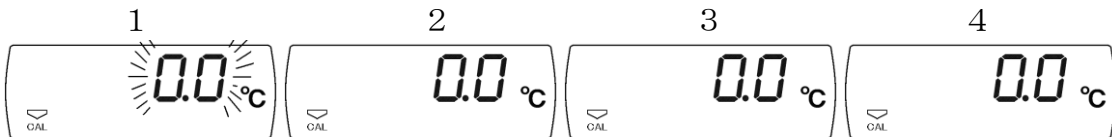

(3) Canceling calibration

In the measurement standby mode, press the CAL key to move to the calibration temperature setup mode.

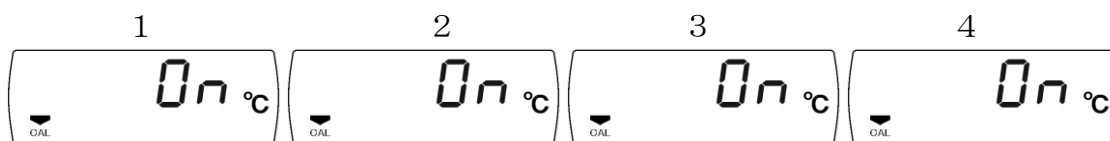

In the calibration temperature setting s, set the temperature to "1r" with the \wedge key and then press the ENT key.

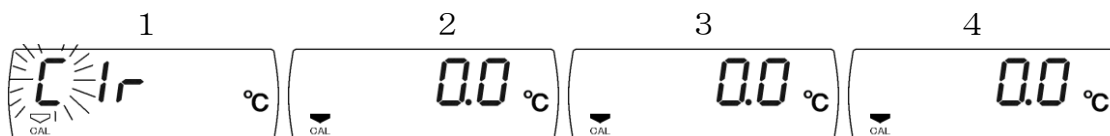

Press the START/STOP key to start measurement.

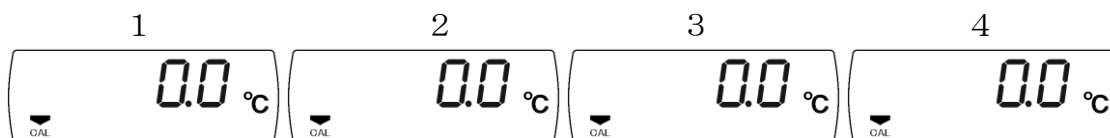

Press the CAL key. When "1r" is displayed, press the ENT key

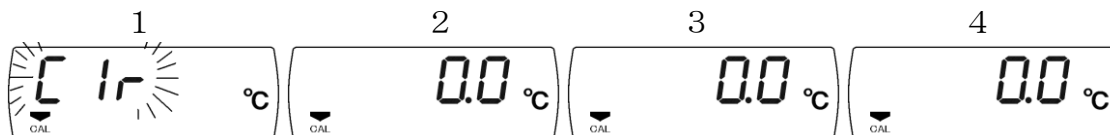

Cancel calibration.

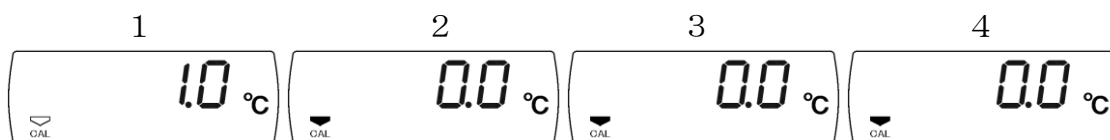

6.2.4 RS-232C Communication

(1) Connecting communication cable

As shown in the figure below, connect a communication cable to the RS-232C connector located on the rear side of the instrument.

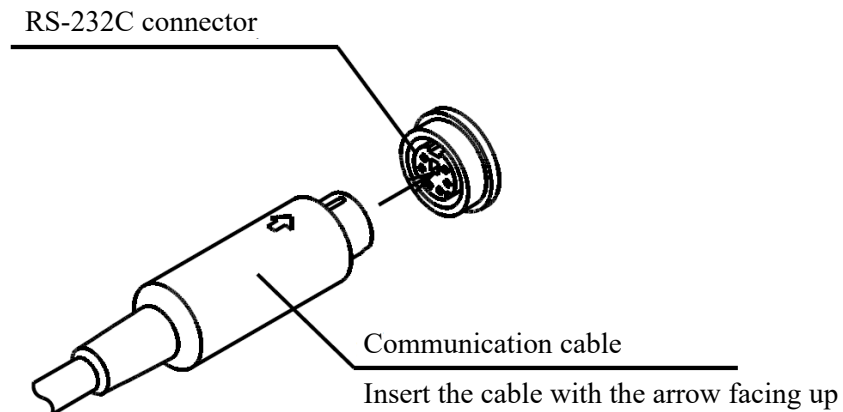

Connect the connector of the other end to a computer.

(2) Installing software (AMS-850) on your computer

Install the program file of AMS-850 from the provided CD-ROM. You cannot start the program from the CD-ROM, so make sure to install the component on the hard disk of your computer and then start up the program.

For more information about installing and operating AMS-850, refer to the provided user's manual for AMS-850.

6.2.5 Analog Output

Analog output is available for each channel under the following conditions through the analog output connector (ANALOG OUT) on the rear panel of the instrument.

Output is made in synchronization with temperature indication, so you can view or record temperature variation by connecting a recorder.

Output range All measurement range

Output rate 10mV/°C

Resolution 1mV

Pin connection



Pin No.	
A	Signal
B	GND
C	N.C.

Voltage output against temperature indication

Temp indication (°C)	Voltage output (mV)
0.0	0
450.0	4500
-195.0	-1950
Err	4500

(Compatible connector: R05-PB3M produced by TAJIMI ELECTRPMOCS)

NOTE

- Do not install this instrument and analog output cable in areas subjected to electromagnetic interference. It may damage the instrument or cause measurement error.

6.2.6 Error Display and Remedies

(1) “Err.” (Error dot)

If “Err.” is displayed upon power-on or during measurement, it means a communication error has occurred in the channel measurement unit. Turn the power OFF then turn it ON again. If the error is not cleared, please contact your distributor or Anritsu Meter.

(2) “Err” (error), “Or” (over) and “-Or” (minus over)

If “Err”, “Or” or “-Or” is displayed during measurement, it indicates measurement failure caused by a problem such as:

- Sensor not connected.
- Sensor damaged.
- Incompatible sensor connected.
- Measured temperature out of the range of instrument and sensor.

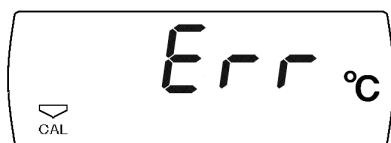

For the case a measured temperature is out of the measurement range of the instrument and sensor, move the instrument and sensor promptly to area where the temperature is within the range to maintain the sensor performance.

Also, check if the specified sensor for the instrument is used, and the sensor is connected properly (see 6.1.1 Connecting Sensor).

If there is no problem in connection, the sensor may be damaged. In this case, please replace the sensor with new one.

When “Err” is still shown on the display even if normality of the sensor is confirmed, please contact your distributor or Anritsu Meter.

7. Maintenance

7.1 Storing the Product

Avoid a location with any of the conditions listed below when storing this product.

- Exposed to direct sunlight
- Subjected to strong vibration
- High humidity (80% RH or higher)
- High temperature (50°C or higher)
- Subjected to dirt, dust, corrosive gas or salt damage
- Within a strong electromagnetic field

When you are not using the instrument, cover the sensor input part with a cap to store the instrument.

We recommend you to store the instrument in the case used at delivery for a long-term storage.

7.2 Cleaning Case

If the case becomes soiled, clean it using a cloth slightly dampened with water.

Do not use organic solvents such as thinner and benzine since these may discolor or deform the case or switch.

7.3 Relocation

Before relocating the instrument, turn off the power switch and disconnect the power cable and connected devices such as sensor.

Be careful not to drop or bump the instrument against any objects to prevent damages on the instrument.

8. Specifications

Input point	4 points
Measurement range	From -195.0 to 450.0°C
Resolution	0.1°C
Accuracy	Calibration not executed: $\pm 2^{\circ}\text{C}$ * $\pm 5^{\circ}\text{C}$ in a range of 400.0-450.0°C Calibration executed: $\pm 0.5^{\circ}\text{C}$ (within $\pm 50^{\circ}\text{C}$ of calibration point) * At an ambient temperature of $25^{\circ}\text{C} \pm 5^{\circ}\text{C}$
Temperature Coefficient	$\pm(0.01\%$ of F.S./ $^{\circ}\text{C})$, within operating temperatures
Display	Height of character: 7.5mm, red LED, five digits
Light source	Blue LED (service life: semipermanent)
Operating environment	Temperature: 0 to 40°C, humidity: 15 to 80% RH (non-condensing)
Storage environment	Temperature: -10 to 50°C, humidity: 10 to 85% RH (non-condensing)
Power supply	220V AC $\pm 10\%$, 50/60 Hz
Power consumption	Approx. 40 VA
External dimensions	320(W) \times 99(H) \times 280(D) mm (protruded parts excluded)
Weight	Approx. 5kg
Measurement timing	Sampling: every 250ms, display update: every second

Interface	RS-232C Transfer rate: 9600bps Data formation: data length 7bit, odd parity, 1 stop bit
Analog output	Output rate: 10mV/°C Resolution: 1mV Accuracy: ±(0.2% of F.S.) (at an ambient temperature of 25°C ±5°C) Temperature coefficient: ±(0.01% of F.S./°C) *Output separately for each channel.
Calibration	One-point calibration (using a real temperature within a measured area) *Calibration can be set individually for each channel.

9. Warranty

Our products are carefully inspected before shipment. However, if your product arrives defective due to manufacturing faults or mishandling during transportation, please contact your distributor or Anritsu Meter.

Our products are warranted for one year from the date of delivery. Failure occurred within the warranty period will be repaired with no charge, provided that the failure is attributable to Anritsu Meter.

Please note that the following cases will not be covered by this warranty in any circumstances.

- Failure or damage resulting from natural disaster such as fire, earthquake and flood, or abnormal voltage.
- Failure or damage caused by inappropriate handling such as dropping or giving an impact to the product while it is transported or relocated by the customer.
- Failure or damage resulting from repair or modification performed by any person other than the repair people from Anritsu Meter.
- Failure resulting from external cause, such as a failure of connected devices, or strong magnetic field that exists near the instrument.
- Failure occurred due to non-compliance with the instructions or cautions in this manual.

This product is repaired at Anritsu Meter and we do not visit customers for repair according to our policy. Please note that the shipping charges are at the customer's expense.

The warranty is valid in Japan only.

Note that temperature sensor is not covered by this warranty since it is considered as a consumable part.



ANRITSU METER CO., LTD.

2-4-5 Shimomeguro, Meguro-ku, Tokyo 153-0064, Japan

Tel +81-3-3491-9181

Fax +81-3-3493-6792

<https://www.anritsu-meter.com/>