



INSTRUCTION MANUAL



HANDHELD THERMOMETER

HA-100 / HA-200 / HA-300 Series

2ed edition March, 2004

ANRITSU METER CO., LTD.

2-4-5 Shimomeguro, Meguro-ku,
Tokyo 153-0064, Japan
Tel +81-3-3491-9181
Fax +81-3-3493-6792



TO ENSURE SAFE AND RELIABLE OPERATION

Please observe the following matters to ensure safe and reliable operation of products.

 Caution

This product should not be used for any purpose except temperature measurement.

Stop using as soon as any problems are discovered.

Do not take the unit apart or remodeling.

Use the specified battery cells or specified AC-Adaptor.

This products is not rechargeable model.

Concerning the battery cells

Please observe the following matters to guard the battery leakage, exothermic reaction and ignition.

 Warning

Do not throw away the battery cells in the fire, and avoid short between electrodes.

Do not charge or heat.

Use the specified battery cells.

 Caution

Set the battery cells correctly 「+」 and 「-」.

Remove the battery cells when the battery life is finished, or long time no using.

Do not mix old and new, or variety battery cells.

The battery life will be affected by the environmental temperature.

Preface

Thank you for purchasing this product from ANRITSU METER CO., LTD.

We prepared this manual so that you can use this product with ease and confidence.

Please read this manual carefully and understand each functions of this product for your safety and correct using.

Caution

This contents and the specification of this product are subject to change without notice.

Reproduction in part or whole of any material from this booklet is prohibited by law.

We surely make this manual, however if there are any error or not clear, please contact the place of purchase or us.

We are not responsible for the consequences of using this product.

After-sales Service

ANRITSU METER CO., LTD. ships products after severe company's inspection. Should you find any failure resulting from poor material and workmanship or accident during transportation, please contact the place of purchase or us.

We recommend that you may use the original packaging for this product when you send it to us for repairing or periodical checkup. If you no longer have the original carton, be sure to use plenty of wrapping to guard against damage during shipping.



e2



CONTENTS

1. General	e4
2. Unpacking	
2.1. Unpacking	e4
2.2. Repacking	e4
3. Name of Components	
3.1. Name of Components	e5
3.2. Display of all segments	e6
4. Preparation for Operation	
4.1. Battery Installation	e7
4.2. AC-power Supply	e8
4.3. How to use Hand Strap	e8
4.4. Sensor Setting	e9
4.5. Soft case	e9
5. Operation	e10
5.1. Power ON / OFF	e11
5.2. Hold	e11
5.3. Automatic Power OFF	e12
5.4. Resolution change	e12
5.5. P / V Hold	e13
5.6. Backlight	e13
5.7. Calibration set	e14
5.8. Alarm	e16
6. Default Configuration	e20
7. Indicator of Battery remain	e21
8. Analog Output	e22
8.1. Connection of recording	e22
9. Error Messages	
9.1. Indication of Sensor Burnout	e23
9.2. Indication of Over range	e23
9.3. Indication of Error	e23
9.4. Indication of Exhausted Battery	e24
10. Maintenance	
10.1. Storage	e24
10.2. Case cleaning	e24
11. In case of Trouble	e25
12. Specification	e26

1. General

This is a handheld thermometer by the latest microcomputer technology.

A microprocessor is used for constant compensation of zero-point and full scale, thus ensuring extremely stable, high precision measurement.

2. Unpacking

2.1. Unpacking

Open the carton and check that the following are provided. If any of them is missing or out of order, please contact the place of purchase or us.

1. Main unit
2. Soft case
3. Analog Output cable (HA-1, HA-2 only)
4. Alarm Output cable (HA-3 only)
5. AA-size alkaline battery cells
6. Instruction manual
7. Warranty

2.2 Repacking

Use the original carton of the instrument for its transportation by mail or car. If the original case is not available, carefully wrap the instrument in shock-absorbing material (polystyrene foam and the like). Wrapping material should be dry and free of dust generation otherwise the instrument may be damaged.

3. Name of Components

3.1. Name of Components (MODEL: HA-3 51)

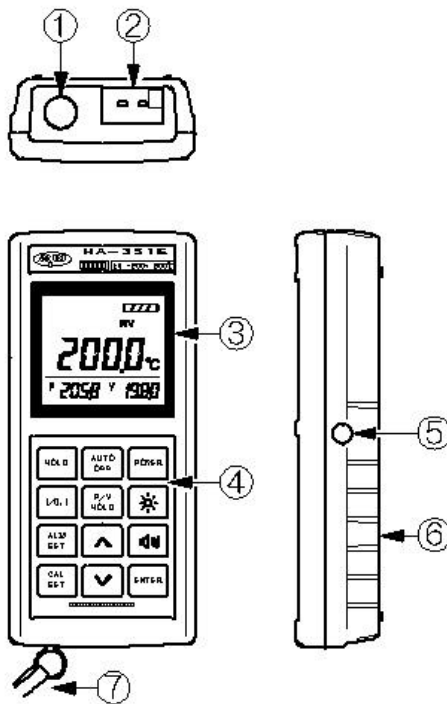

- Alarm Output / Analog Output connector
- Sensor Input connector
- LCD Display
- Key switch panel
- AC adaptor jack
- Battery housing
- Hand strap

3.2. Display of all segments

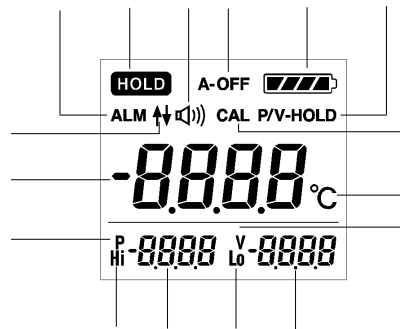

Segments	HA-1**	HA-2**	HA-3**
Alarm			
Hold			
Alarm Buzzer			
Auto-power-off			
Battery			
P/V Hold			
alarm			
Main display			
Peak			
Calibration			
Valley			
Hi			
Sub-display 1			
Lo			
Sub-display 2			

4. Preparation for Operation

4.1. Battery Installation

Be sure to keep the power OFF during the battery cells change.

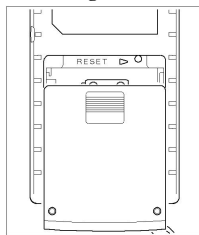

(1) Open the battery housing cover.

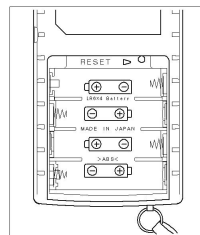

(2) Set battery cells correctly.

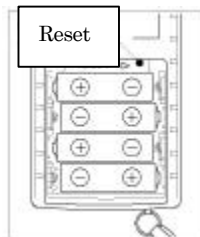

(3) After setting battery cells, press the Reset switch.

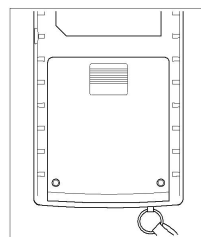

(4) Close the battery housing cover completely.

The Reset switch is a small push button in the upper section of the battery housing. Use a thin stick to lightly press it.

When the Rest button is pressed, operation begins in the same way as power is turned ON, and the instrument will be ready for measurement. When measurement is not intends after battery change, turn power OFF.

4.2. AC-power Supply

- (1) After turning power OFF, connect the AC-adaptor connection plug to the main unit as shown.

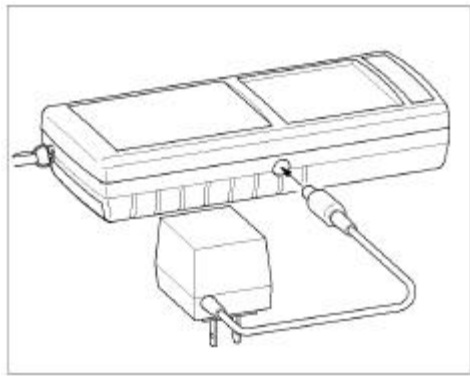

- (2) Connect the power plug of the AC-adaptor to commercial power (100V AC).

When the AC-adaptor is connected during operating the battery, the internal battery circuit will be cut OFF as same as Reset.

Be sure to use the specified AC-adaptor. The AC-adaptor for the HA series is available as an option.

4.3. How to Use Hand Strap

Hang the hand strap around the hand to prevent in advertent drop of the instrument.

4.4. Sensor Setting

Set the sensor as shown.

The plug is so designed that it will not be set when the polarity is reversed.

Forcible insertion will damage the instrument.

Be sure to check the polarity.

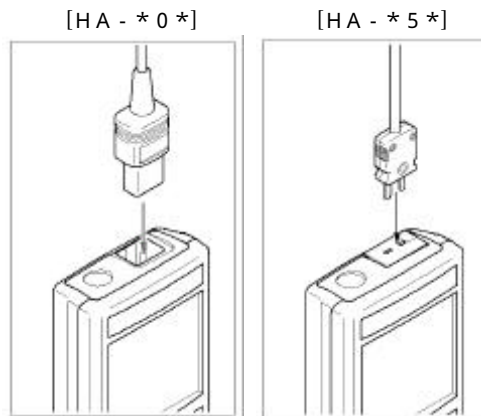

4.5. Soft case

Use the attached soft case for protection instrument against dirt or flaw.

In case of the combined use attached Soft case and the AC-adaptor, please bore the hole at the AC-adaptor jack part of Soft case by scissors, etc.

5. Operation

HA-100 / 200 / 300 series come in a variety of models shown below.

Table of the Function and HA series

Function	HA-1**	HA-2**	HA-3**
Power ON/OFF			
Hold			
Automatic Power OFF			
Resolution change			
P/V hold *			
Backlight			
Calibration			
Alarm			

Analog Output model

	HA- **1	HA- **2
1mV/		
10mV/		

5.1. Power ON/OFF

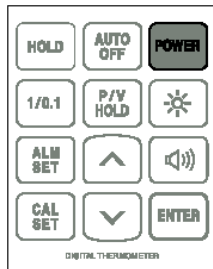

Press the Power key to turn power ON and all segments appear on the display for 1 second, and start measurement as be shown below.

Press the key again to turn power OFF.

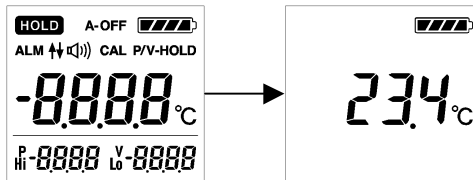

5.2. Hold

Press the HOLD key to stop measurement and show the measured Temperature on the display.

Then HOLD appears on the display.

Press the key again to return to the normal mode.

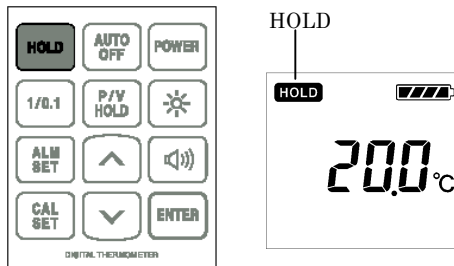

5.3. Automatic Power OFF

Press the AUTO OFF key to enter the Automatic Power OFF mode that is provided to automatically turn Power OFF after a certain period time (about 5 minutes) no key operation. Press the key again to return to normal mode.

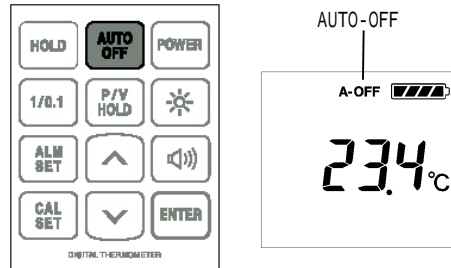

5.4. Resolution change [HA-2** /HA-3**]

Press the 1/0.1 key to change the resolution of the displayed temperature.

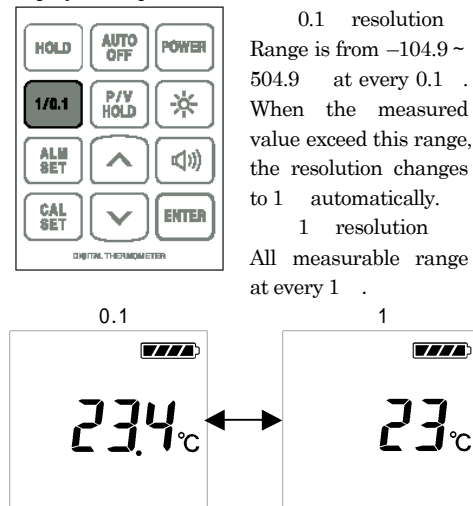

5.5. P/V Hold [HA-2** / HA-3**]

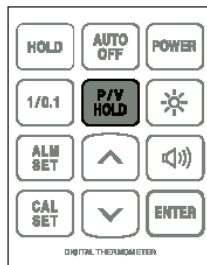

Press the P/V HOLD key to enter P/V Hold mode that the maximum value, the minimum value and the present value are displayed simultaneously. Press the key again to return normal mode.

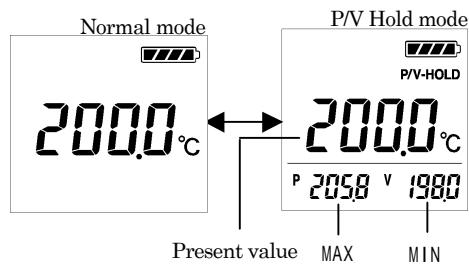

5.6. Backlight [HA-2** / HA-3**]



Press the key to turn the backlight ON, and the display on the screen will be visible even in the dark. Press the key again to turn the backlight OFF.

The battery consumption is double when the backlight is ON.
Be sure to turn OFF the backlight.

5.7. Calibration set [HA-3**]

This function permits calibration of a measured

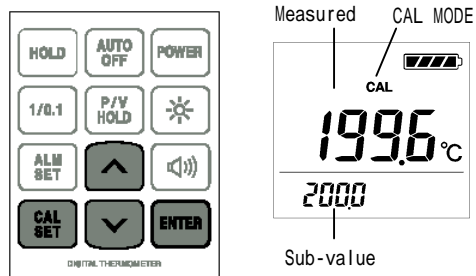

value.

(1) Calibration set

Touch the sensor probe to the target and press the CAL SET key.

The calibration value is added the adjusted value of last calibration set. In case of above the display, the adjusted value is +0.4 .

Set the calibration value (Sub-value) to the desired temperature by pressing the key and the key.

The sub-value for calibration is limited to ± 10

Press the ENTER key to complete calibration setting, and enter the calibration mode.

If the CAL SET key is pressed before the completion of calibration setting, this mode will be canceled and return to normal mode.

(2) Calibration mode

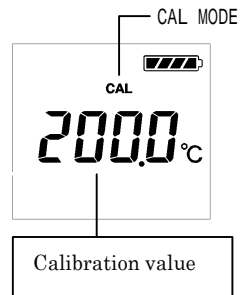

CAL appears on the display. The Main display indicates the calibration value that is added the adjusted value. In case of the shown display, the present value is 199.6 , the adjusted value is +0.4 .

(3) Canceling calibration

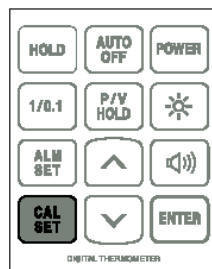

Press the CAL SET key twice to cancel calibration mode.

5.8. Alarm [HA-3**]

This function presets high / low limits and gives the alarm when the measured value goes beyond the limits.

The alarm function is set in the ON position at all measurement.

When the measured value goes beyond limits, ALM appears on the display.

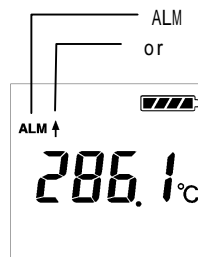

Measurement condition	Display
High limit < Measured value	A L M
Low limit > Measured value	A L M
Within limits	NON

(1) High/Low limit setting

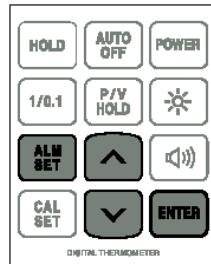

Press the ALM SET key to change the setting display as shown.

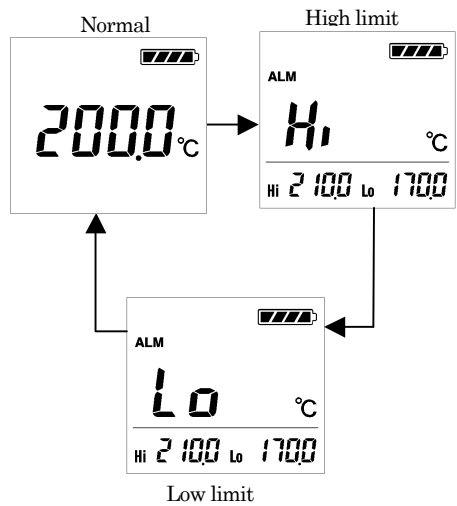

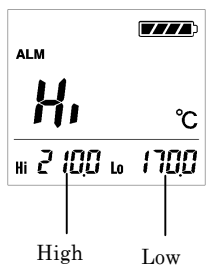

Set the high limit or low limit setting with the key and the key.

When the keys are kept pressing, value will be changed by 10 steps.



Press the ENT key to end setting.
 If the ALM SET key is pressed before the completion of Alarm setting, this mode will be canceled and return to normal mode.

(2) Alarm Buzzer ON / OFF

Press the  key to turn the alarm buzzer ON and ALM and  are appeared on the display.

When the measured value goes beyond limits, the alarm buzzer sounds.

Press the key again to return to normal mode.

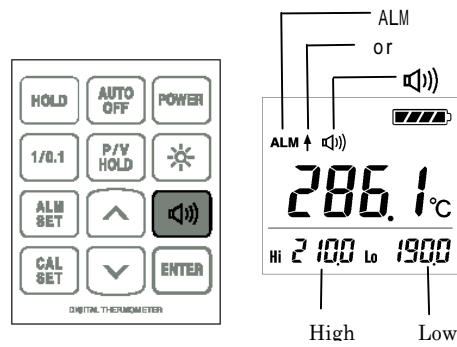

(3) Alarm Output

Signal names and Connector pin arrangement

Pin No.	Signal name
1	ALM 1 (MAX)
4	ALM 2 (MIN)
2	V 1 (Power 1)
3	V 2 (Power 2)

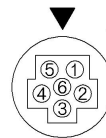

ALM1 and ALM2 are directly coupled with C-MOSIC.

Output Signal

Output signal is digital (" L " 0V / " H " 5V) as below table from comparison of the present value and the high / low limits.

Measured value	A L M 1	A L M 2
Over High	" L "	" H "
Within Limits	" H "	" H "
Below Low	" H "	" L "

Signal takeout and example of use

Shown circuit is an example of simple temperature measurement (ON / OFF control) with the high limit alarm.

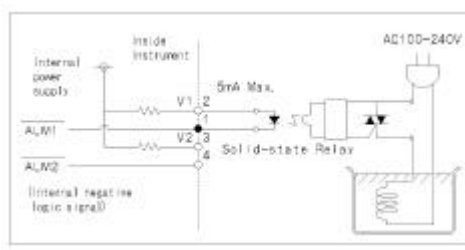

Signal current of up to 5 mA can be taken out. Examine the junction circuit (driver, etc.) in accordance with the driving load.

Be sure to turn the power OFF before connecting to or separating from other equipment.

6. Default Configuration

When the instrument turns the power OFF, Reset or Battery exchange, some setting will be canceled. Default Configuration is below tables.





Function	
HOLD	Cancel
Auto Power OFF	Default
P / V Hold	Cancel
Resolution	Default
Backlight	Cancel
Alarm	Default
Alarm buzzer ON / OFF	Cancel
Calibration set	Default
Calibration ON / OFF	Default

7. Indicator of Battery remain

The battery level is indicated in the upper section of the display. In accordance with operation hours, the indicator lights go out as shown below.



This table is tentative value because of the battery remains according to variety battery specification.

Indicator	Battery remain
	Over 50 %
	25 ~ 50 %
	10 ~ 25 %
	Under 10 %
	Exhausted Battery

This instrument can work for a while after the Exhausted Battery sign appears. However, Change battery as soon as possible, otherwise satisfactory function will not be available.

8. Analog Output [HA-**1 ,HA-**2]

There are two analog output rates. The rate of output is shown in follow table.

Model	Rate	Output range
HA - **1	1mV /	All measurable range at 1 resolution
HA - **2	10mV /	- 100.0 ~500.0 at 0.1 resolution

When the display is the Over range or the Burned out etc., the Analog Output is shown in follow table.

Plus Over : About 5 1 0 0 m V
Minus Over : About - 2 2 0 0 m V
Burn out : About - 2 3 0 0 m V

Signal names and Connector pin arrangement

Pin No.	Signal name
5	+ side
6	- side



8.1. Connection of Recording

- (1) Turn off the power of recorder and instrument.
- (2) Connect the red terminal of the attached the Analog Output cable to the positive: + side of the recorder terminal and the black terminal to the negative: - side of the recorder terminal.
- (3) Adjust the recorder input range to the measuring range of the instrument.
- (4) Turn on the power of recorder and instrument.
- (5) Check the Automatic Power OFF mode is

canceled.

Caution: Never short-circuit the cable or cable itself otherwise failure will result.

9. Error Messages

9.1. Indication of Sensor Burnout

If the sensor burns out or is not coupled, the Burnout display appears shown as right.

Check whether the sensor burns out or does not connect to instrument.

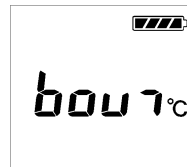

9.2. Indication of Over range

If the temperature exceeds the measurable range during measuring, the Over range display appears shown as right.

If the sensor is almost cut, the Over range display sometimes appears.

Please check the sensor cut if measuring temperature is in the range.

The over range display does not damage the instrument, however the sensor will be exhausted. Avoid the

sensor to the place in measurable temperature.

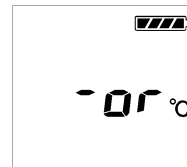

9.3. Indication of Error

The instrument is broken,



please contact the place of purchasing.

9.4. Indication of Exhausted Battery

When the battery is exhausted, Battery indicator blinks. Then replace the old battery cells with new ones.

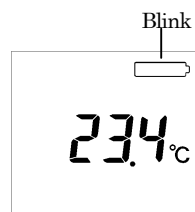

10. Maintenance

10.1. Storage

Avoid places subject to the following when storing the instruments.

- Direct Sunlight
- Strong vibration
- High humidity (85% RH or more)
- Hot atmosphere (50 °C or more)
- Dust, corrosive gas, or salt
- Strong electromagnetic field

It is recommended to put the instrument in the original case when storing it for a long time.

10.2. Case cleaning

When the case is dirty, lightly wipe it with a cloth slightly impregnated with water or petroleum. Do not use thinner or benzene, otherwise the case or keyboard may discolor or deform.

11. In case of Trouble

Issues of instruments operation trouble, please check follows. If your trouble is not solved, please contact the place of purchase or us.

- (1) Display does not show any segments.
 - Push the Reset switch
 - Check the pole of battery cells
 - Replace the old battery with new ones
 - If you use the AC-Adaptor, please pull it out.
- (2) Measurement value does not stable.
 - If sensor is deformation or broken junction, please contact us for repairing.
 - Pull out and put in the plug of the sensor with the instrument again.
 - If the sensor does not hold in the correct position, measurement value does not stable.
 - If you measure in the environment of strong electromagnetic field (a big motor, etc.), please shield the instruments and the sensor against electrical noise.
- (3) Measurement value error is too big (Not acceptable).
 - If the thermocouple type of the sensor is not corresponded to the instruments, measurement value is not correct. Please replace the correct sensor.
 - If sensor is deformation, please contact us
- (4) The key switch is not operated
 - When the Burn out display appears, no operation. Please put the sensor in, or check the sensor broken junction.

12. Specification

Display	7 segments LCD display
Operation key	Membrane switch
Linearizer	Digital (based on JIS C 1602-1995)
Sampling rate	Approximately 300 ms
Signal source resistance	500
Power supply	Battery cells (AA) 4 pieces or AC adaptor
Battery life	Approximately 300 h
Environmental limit	Operation : 0 ~ 40 °C, 0 ~ 80% RH Storage : -20 ~ 50 °C, 0 ~ 80% RH
Dimensions	71(W) × 160(H) × 35(D)mm
Weight	Approximately 250 g
Accessories	Soft case Instruction manual Battery cells (AA) 4 pieces HA-3** : Alarm Output cable HA-**1, HA-**2 : Analog Output cable

Analog Output (HA-**1, HA-**2)

Model	HA-**1	HA-**2
Rate	1 mV/	10 mV/
Range	All range at 1 resolution	All range at 0.1 resolution
Resistance	100	
Accuracy	$\pm (0.15\% \text{ of F/S} + 1 \text{ mV})$ at 25 °C ± 5 $\pm (0.15\% \text{ of F/S} + 1 \text{ mV}) \pm (0.01\% \text{ of F/S})$ except 25 °C ± 5	

Alarm (HA-3**)

Measured value	A L M 1	A L M 2
Over high	“ L ”	“ H ”
Within Limits	“ H ”	“ H ”
Below low	“ H ”	“ L ”

Accuracy

E	Measurement range *1	1	-200 ~ 800
		0.1	-100.0 ~ 500.0
	Accuracy 1 resolution	0 ~ 800 ± (0.1% of reading + 1) -200 ~ -1 ± (0.5% of reading + 1)	
	Accuracy 0.1 resolution	0.0 ~ 500.0 ± (0.05% of reading + 0.2) -100.0 ~ 0.1 ± 0.5	
K	Measurement range *2	1	-200 ~ 1200
		0.1	-100.0 ~ 500.0
	Accuracy 1 resolution	0 ~ 1370 ± (0.1% of reading + 1) -200 ~ -1 ± (0.5% of reading + 1)	
	Accuracy 0.1 resolution	0.0 ~ 500.0 ± (0.05% of reading + 0.2) -100.0 ~ 0.1 ± 0.5	
	Accuracy Cold-junction compensation	0.2 at 25 ± 10	
	Temperature coefficient	± 0.01 % of F/S /	

*1, *2: Indicator range is wider than measurement range. (approximately 2 ~ 5)